

NATURPOOL

KLINKER SOLUTIONS · IN & OUT

NATUCER

NATUCER, S.L. C/ Les Forques, 2
12200 Onda [Castellón] Spain · Apdo. nº 6
Tel.: + [34] 964 60 40 66 [8 líneas] · Fax: + [34] 964 77 16 10
[Dpto. Cont. y Admon.]: natucer@natucer.es · Fax: + [34] 964 77 16 10
[Dpto. Com. Nac.]: nacional@natucer.es · Fax: + [34] 964 60 24 25
[Dpto. Com. Exp.]: comercial@natucer.es · Fax: + [34] 964 77 16 10
[Dpto. Técnico y Lab.]: laboratorio@natucer.es
www.natucer.es

NATUCER



OUT

Solución para el exterior de la piscina

Special pieces for outside pool

PIEZAS ESPECIALES PARA UN ACABADO PERFECTO Y COORDINADO
SPECIAL PIECES FOR A PERFECT FINISH



**PAVIMENTO
ANTISLIP**
100% SEGURIDAD
fine **RESISTANCE**
CLASE III - R11 - CLASE C

IN

Solución para el vaso de piscina

Special pieces for inside pool

REVESTIMIENTO ESPECIAL PARA VASO DE PISCINA POOL PORC.
SPECIAL TILES FOR THE INTERIOR OF THE SWIMMING POOL
IN PORCELAIN FINISH

NATURPOOL

KLINKER SOLUTIONS · IN & OUT

Natucer ofrece soluciones integrales para piscinas. Un paquete completo formado por **DOS CONCEPTOS** diferenciados entre si. La fórmula perfecta: dentro y fuera (IN & OUT)

1. Solución para el vaso de piscina (IN)

Revestimiento Porcelánico en formato 10x10 con una gama cromática repleta de matices que llenarán de armonía y luminosidad el interior de la piscina.

2. Solución para el exterior de la piscina (OUT)

Piezas especiales y técnicas para piscina, y pavimento porcelánico antideslizante destinado a la construcción de la playa y terrazas.

Natucer ofrece soluciones técnicas y estéticas para piscinas realizadas con Gres Porcelánico Extruido. Un material extremadamente resistente, higiénico y seguro. Piscinas 100% personalizadas que se convierten en una prolongación estética de la terraza, creando exteriores totalmente integrados.

Natucer offers all kind of solutions for swimming pool projects. The perfect and most complete concept: IN & OUT

1. Solutions for the interior of the pool. (IN)

Porcelain tiles in 10x10 with a very modern chromatic range that will flood of harmony and light your pool.

2. Solutions for the exterior of the pool. (OUT)

Special pieces for the pool and porcelain antislip floors for terraces and beach area.

Natucer offers technical and aesthetical solutions for swimming pools, using our Extruded Porcelain Tiles, extremely resistant, hygienic and safe.

100% customized swimming pools that become an aesthetic continuation of your terrace, creating exteriors full of design and harmony.

TERRACE + POOL INTERIOR IN&OUT SOLUTIONS

EVOLUTION
EXTRUDED PORCELAIN TILE

fine **RESISTANCE**

AntiSlip

ANTI-BACTERIAL

VENTAJAS

DE USAR GRES PORCELÁNICO EXTRUIDO

ADVANTAGES OF USING EXTRUDED PORCELAIN TILE

El Gres Porcelánico Extruido posee unas cualidades inmejorables gracias a la materia prima y su proceso de fabricación. Ideal para proyectos de piscinas y terrazas.

Extruded Porcelain Tile has incredible features thanks to its raw material and its manufacturing process. Perfect for swimming pool and terrace projects.



100% SEGURIDAD

La cerámica de Natucer presenta un alto grado de antideslizamiento indispensable para garantizar la seguridad tanto en la zona de playa como en el borde y vaso de la piscina.

CLASE III · R11 DIN 51097: CLASE C

Su alta capacidad antideslizante la hacen idónea para su uso en zonas húmedas, evitando caídas y resbalones.

fine RESISTANCE

Natucer presenta un acabado especial que elimina la rugosidad característica del producto antideslizante, obteniendo una superficie fina y suave al tacto.

100% SAFE

Natucer ceramics presents a high degree of antislip effect to ensure safety both in the beach area as on the border and interior of the swimming pool.

Its high antislip resistance makes the product ideal to be used in wet areas.

Natucer introduces a special finish avoiding the typical roughness on the antislip product, obtaining a flat and soft surface.



PRODUCTO HIGIÉNICO

La cerámica posee propiedades antibacterianas que la convierten en el material ideal para cubrir suelos en contacto con el agua.



1 Impide el crecimiento de bacterias y otros microorganismos.

2 Facilita la limpieza de la superficie.

3 Ayuda a descomponer los contaminantes del aire y los malos olores.

PORCELÁNICO EXTRUIDO + JUNTA DE COLOCACIÓN = 100% PROTECCIÓN

HYGIENIC PRODUCT

This ceramics has antibacterial properties, the ideal material to cover floors in contact with water.

1 Avoid bacterial and other microorganisms growth.

2 Easy surface cleaning

3 Decompose the air-polluting agents and smells.

EXTRUDED PORCELAIN + INSTALLATION JOINT = 100% PROTECTION



RESISTENTE A LOS QUÍMICOS

La cerámica es resistente a los agentes químicos de limpieza y a los aditivos que se utilizan para la conservación del agua; correctores del pH, alguicidas, floculantes, cloro, productos antical, bromo, etc. También es resistente a los tratamientos del agua de piscina con sal.

CHEMICAL RESISTANT

Our ceramics is resistant to chemical cleaning agents and additives used for water conservation; pH correctors, algacides, flocculants, chlorine, anti-calcium products, bromine, etc. It is also resistant to salt water swimming pool treatments.



IGNÍFUGO

La cerámica no arde y, en caso de incendio, no emite sustancias nocivas, ni para las personas ni para el medio ambiente.

FIREPROOF

Ceramic tiles do not burn, and in case of fire, damaging substances for people or environment are not released.



FÁCIL MANTENIMIENTO

El mantenimiento del Porcelánico Extruido es mínimo. Resistente a manchas y químicos. Su limpieza es fácil y rápida, tan simple como aplicar agua a presión.



EASY MAINTENANCE

The maintenance of extruded porcelain is minimal. Resistant to stains and chemicals, it is easy and fast to clean; just need to apply pressurized water.



ECOLÓGICO

La cerámica es un producto totalmente reciclable que no contiene plásticos. Respeta el medio ambiente ya que se fabrica conforme a las normativas europeas más rigurosas.

ECO-FRIENDLY

Ceramic tiles are completely recyclable with no plastic content. Environmentally-friendly since it is produced under the most strict European normative.



DURADERO Y RESISTENTE

La cerámica de Natucer es un producto para toda la vida. Entre sus características destaca su alta durabilidad al mantenerse inalterable ante las radiaciones solares, el contacto continuo con el agua y los productos químicos.

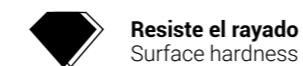
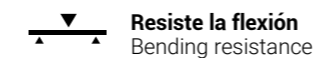

DURABLE AND RESISTANT

Natucer ceramics is a product for life. Among its features, it stands out its high durability by staying unchanged against solar radiation, continuous contact with water and chemical products.



CONTINUIDAD ESTÉTICA

Terrazas y piscinas con continuidad estética. Mismo diseño, color y acabado para una visión global uniforme. Una integración total de la piscina con el entorno que la rodea, unificando así el estilo de los espacios exteriores.

AESTHETIC CONTINUITY

Terraces and swimming pools with aesthetic continuity. Same design, color and finish for a uniform atmosphere. A total integration of the swimming pool through a surrounding environment, unifying the style of outdoor spaces.



ACABADO PERFECTO

Gracias a las propiedades de la cerámica podemos utilizarla para revestir el interior de la piscina. Para ello contamos con infinidad de piezas especiales que garantizan un acabado perfecto.



PERFECT FINISH

Thanks to the ceramic properties, we can use it to cover the interior of the swimming pool. We provide special pieces that guarantee a perfect finish.



PISCINA PERSONALIZADA

La cerámica ofrece infinidad de combinaciones decorativas para crear piscinas únicas y personalizadas al 100% gracias a su variedad de formatos, colores, acabados y estilos.

La cerámica es versátil, auténtica, capaz de aportar estilo y valor a cualquier espacio.

1 Elige un estilo

2 Elige un tipo de coronación

3 Combina con nuestro revestimiento para interior de piscina

CUSTOMIZED SWIMMING POOL

Ceramic offers endless decorative combinations to create unique and customized swimming pools thanks to its variety of formats, colours, finish and styles.

Ceramics is versatile, genuine, always providing style, everywhere.

1. Choose a style

2. Choose a crowning system

3. Combine with our indoor swimming pool tiles.

TIPOS DE PISCINA SEGÚN SU CORONACIÓN

DIFFERENT CROWNING SYSTEM SWIMMING POOLS

06 - 45



DESBORDANTE OVERFLOWING POOL

Las piscinas desbordantes son aquellas en las que la lámina de agua rebosa por encima de los niveles del borde, creando así un efecto visual impactante a modo de laguna. Su canalización de desagüe se realiza en la superficie de la playa a través de una rejilla de características especiales. Este sistema permite una constante renovación del agua de la piscina.

Overflow swimming pools are those in which the water horizon runs over the level of the pool border, creating a "lake" visual effect.

Its drainage is done through a grill on the surface of the beach floor, that finish in a channel pipe that recycles water constantly.



PISCINA DESBORDANTE CON CANALIZACIÓN CON REJILLA

OVERFLOW SWIMMING POOL
WITH GRILL CHANNEL

06 - 11

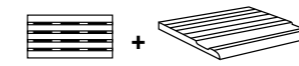

PISCINA DESBORDANTE CON CANALIZACIÓN CON GRATTING

OVERFLOW SWIMMING POOL
WITH GRATTING CHANNEL

12 - 19



INFINITY INFINITY POOL

Las piscinas Infinity son una variante de piscina desbordante. El agua suele rebasar uno o varios de los bordes de la piscina y cae verticalmente a un vaso de compensación oculto. Destacan por su gran atractivo estético.

Infinity pools are a variation of overflow pools. Water level overpasses one or more than one of the pool borders, falling vertically inside a hidden compensation container.

They are popular thanks to its great aesthetic beauty.



20 - 23



SKIMMER SKIMMER POOL

En las piscinas Skimmer o piscinas tradicionales el agua se encuentra aproximadamente a 20 cm por debajo del borde. A esta altura se encuentran unas aberturas (skimmers) que sirven para filtrar y asegurar la limpieza automática del agua. Son piscinas muy funcionales y las más habituales pues requieren de menos mantenimiento.

In Skimmer swimming pools or traditional pools water level in 20 cm below the pool border. Here we find the skimmers, entrances for cleaning and filtering water. These are very functional swimming pools, and also the most usual. In these pools, less maintenance is required.

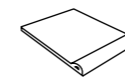

PISCINA SKIMMER CORONADA CON BORDE DE PISCINA

SKIMMER SWIMMING POOL
CROWNED WITH
POOL BORDER TILES

24 - 33



PISCINA SKIMMER CORONADA CON PELDAÑO 120

SKIMMER SWIMMING POOL
CROWNED WITH 120 CM STEP

34 - 37

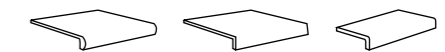

PISCINA SKIMMER CORONADA CON PELDAÑO CURVO / PELDAÑO ANGULAR / VIERTEAGUAS

SKIMMER SWIMMING POOL
CROWNED WITH ROUNDED STEP,
ANGULAR STEP, WINDOW RAIL

38 - 45

SOLUCIONES VASO DE PISCINA · REVESTIMIENTO POOL PORC.

SOLUTIONS INSIDE THE POOL · SWIMMING POOL WALL AND FLOOR PORC.

46 - 51

REVESTIMIENTOS COORDINADOS CON TERRAZAS

POOL REVESTMENT COMBINING TERRACES AND BEACH OF THE POOL

52 - 53



SISTEMA DESBORDANTE OVERFLOW SYSTEM

CANALIZACIÓN CON REJILLA GRILL CHANNEL



Pavimento Tech-Land Fire 30x30 · 11,8" x11,8"
Desbordante Tech-Land Fire 30x30/2,2 · 11,8" x11,8"
Esquina Desbordante Int. Tech-Land Fire 30x30x41,5 · 11,8" x11,8" x16"
Rejilla Tech-Land Fire 12,5x30/2,2 · 4,9" x11,8"
Esquina Rejilla Tech-Land Fire 12,5x12,5/2,2 · 4,9" x4,9"

Revestimiento Piscina:
Pool Porc. Emerald 10x10 · 4" x4"
Media Caña Int. Pool Porc. Emerald 3x20/3 · 1" x8" x1"
Cubrecanto Pool Porc. Emerald 3x20/3 · 1" x8" x1"
Comp. Int. Media Caña Pool Porc. Emerald 3x3 · 1" x1"
Comp. Ext. Media Caña Pool Porc. Emerald 3x3 · 1" x1"
Comp. Int. Cubrecanto Pool Porc. Emerald 3x3 · 1" x1"
Comp. Ext. Cubrecanto Pool Porc. Emerald 3x3 · 1" x1"



SISTEMA DESBORDANTE
OVERFLOW SYSTEM

Para conseguir el efecto desbordante se debe instalar una canaleta de filtrado por todo el perímetro de la piscina por dónde el agua entrará de forma constante. Esta canaleta se cubre con nuestras rejillas cerámicas.

In order to get the overflow effect, one filter channel should be installed in all the perimeter of the pool, where water will be constantly flowing. This channel will be covered with our ceramic tile grill.

CANALIZACIÓN CON REJILLA
GRILL CHANNEL

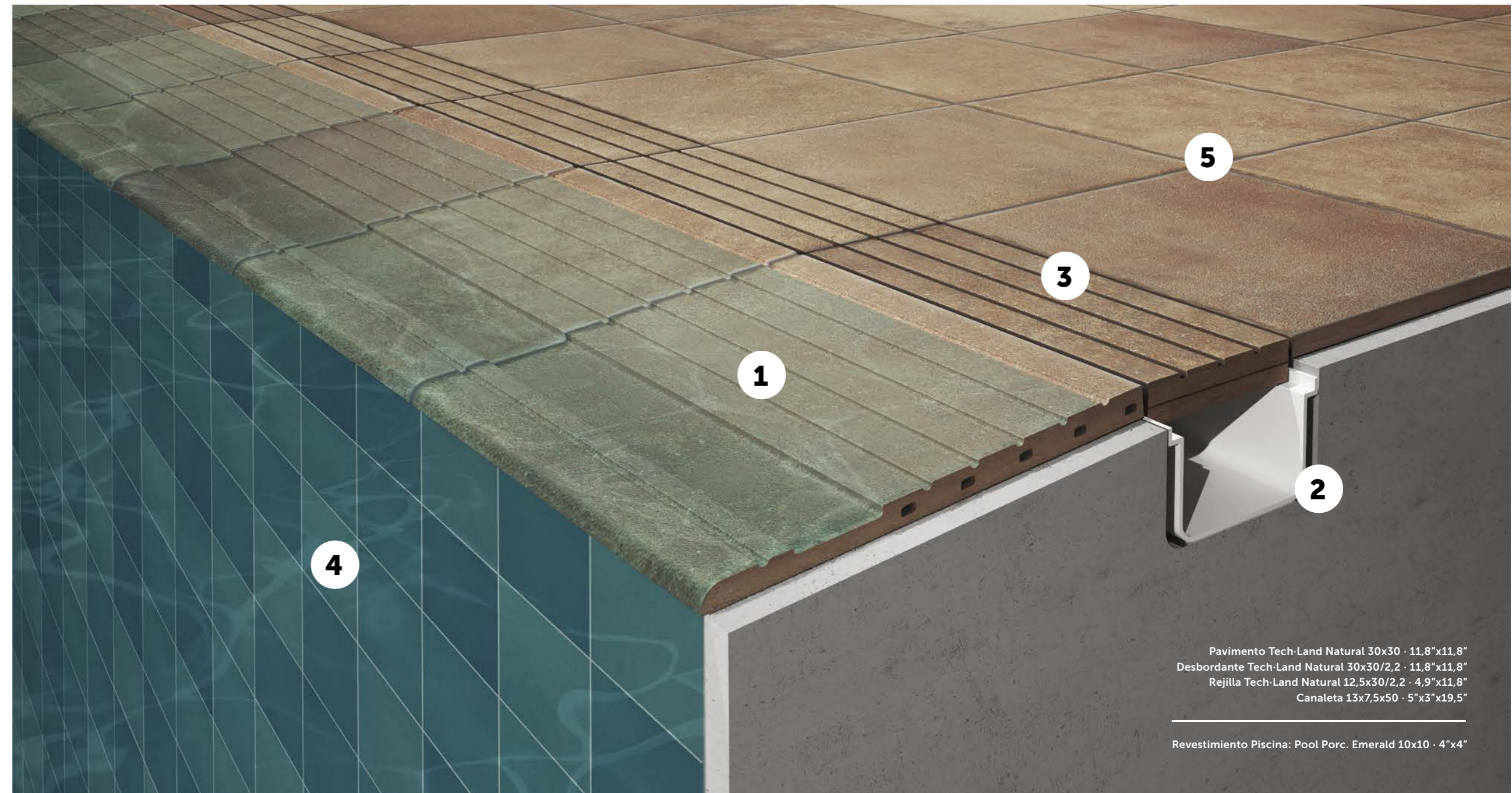
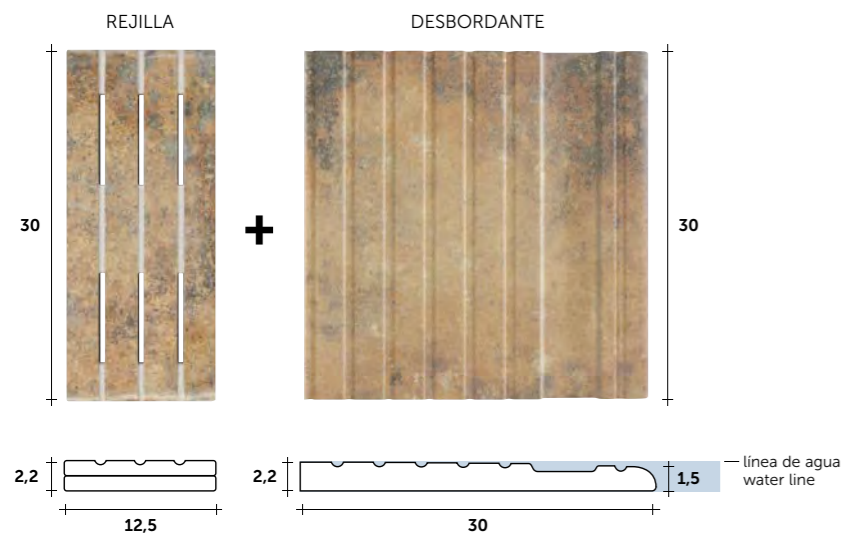

Pavimento Tech-Land Natural 30x30 · 11,8"x11,8"
Desbordante Tech-Land Natural 30x30/2,2 · 11,8"x11,8"
Rejilla Tech-Land Natural 12,5x30/2,2 · 4,9"x11,8"
Canaleta 13x7,5x50 · 5"x3"x19,5"

Revestimiento Piscina: Pool Porc. Emerald 10x10 · 4"x4"

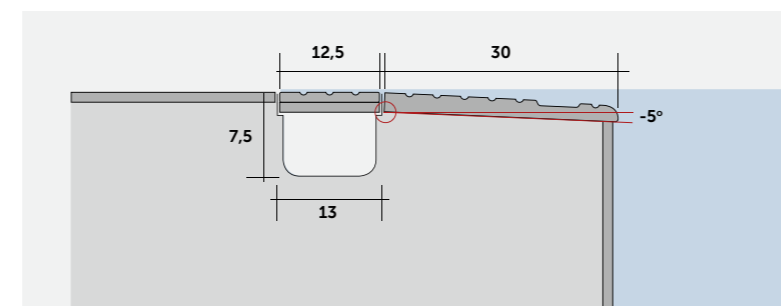

PACKING

FORMATO	PULGADAS	PZ/CAJA	ML	CAJA/PLT	PESO/CAJA	PESO/PLT
30 x 30/2,2 DESBORDANTE	11,8" x 11,8"	7	2,1	44	20,69	930
12,5 x30/2,2 REJILLA	4,9" x 11,8"	10	3	36	20,4	735
12,5 x60/2,2 REJILLA	4,9" x 23,6"	5	3	66	18	1.190
13 x 7,5 x 50 CANALETA	5" x 3" x 19,5"	24	12	20	13,5	300
30 x 30 x 41,5/2,2 ESQ. EXT. DESBORD.	11,8" x 11,8" x 16"	2	0,6	90	6,3	578
30 x 30 x 41,5/2,2 ESQ. INT. DESBORD.	11,8" x 11,8" x 16"	2	0,6	90	6,3	578
12,5 x 12,5/2,2 ESQ. REJILLA	4,9" x 4,9"	24	3	66	18,24	1.210

FORMATO	PULGADAS	PZ/CAJA	M ²	CAJA/PLT	PESO/CAJA	PESO/PLT
10 x 10 REVESTIMIENTO	4" x 4"	50	0,5	120	10,5	1.275
30 x 30 PAVIMENTO	11,8" x 11,8"	10	0,90	60	25	1.520

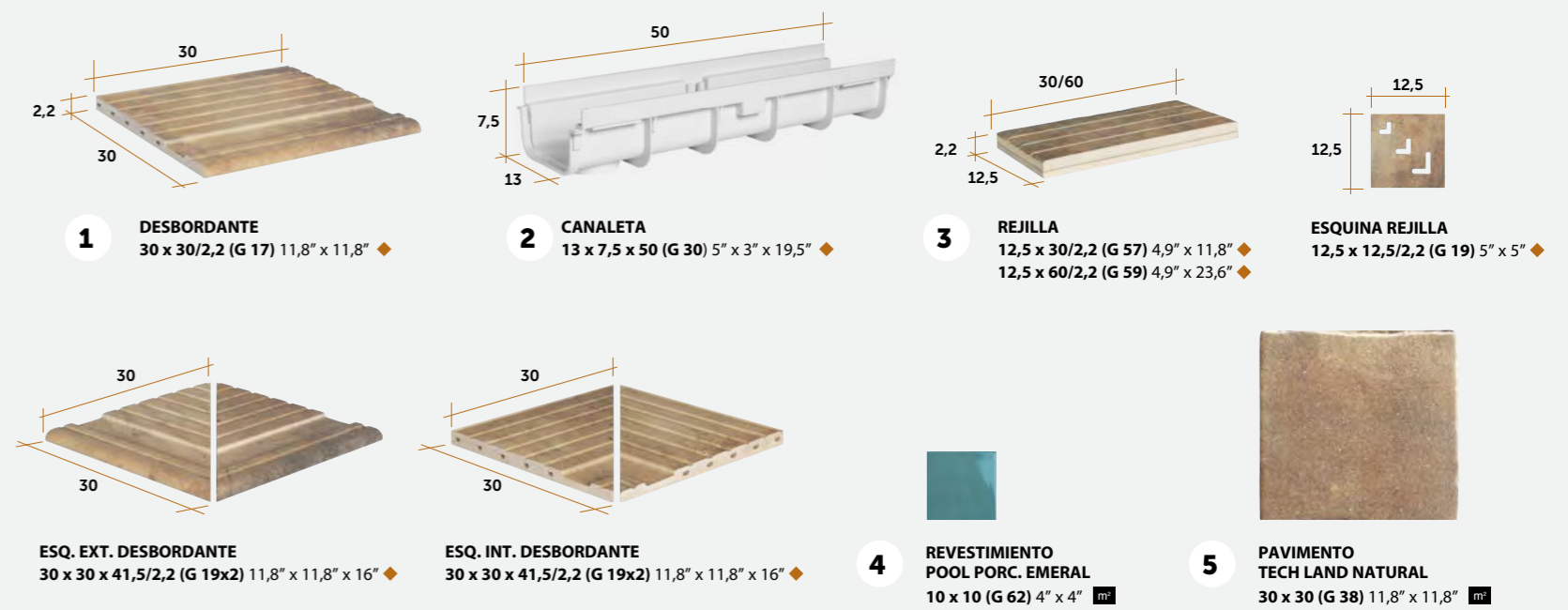

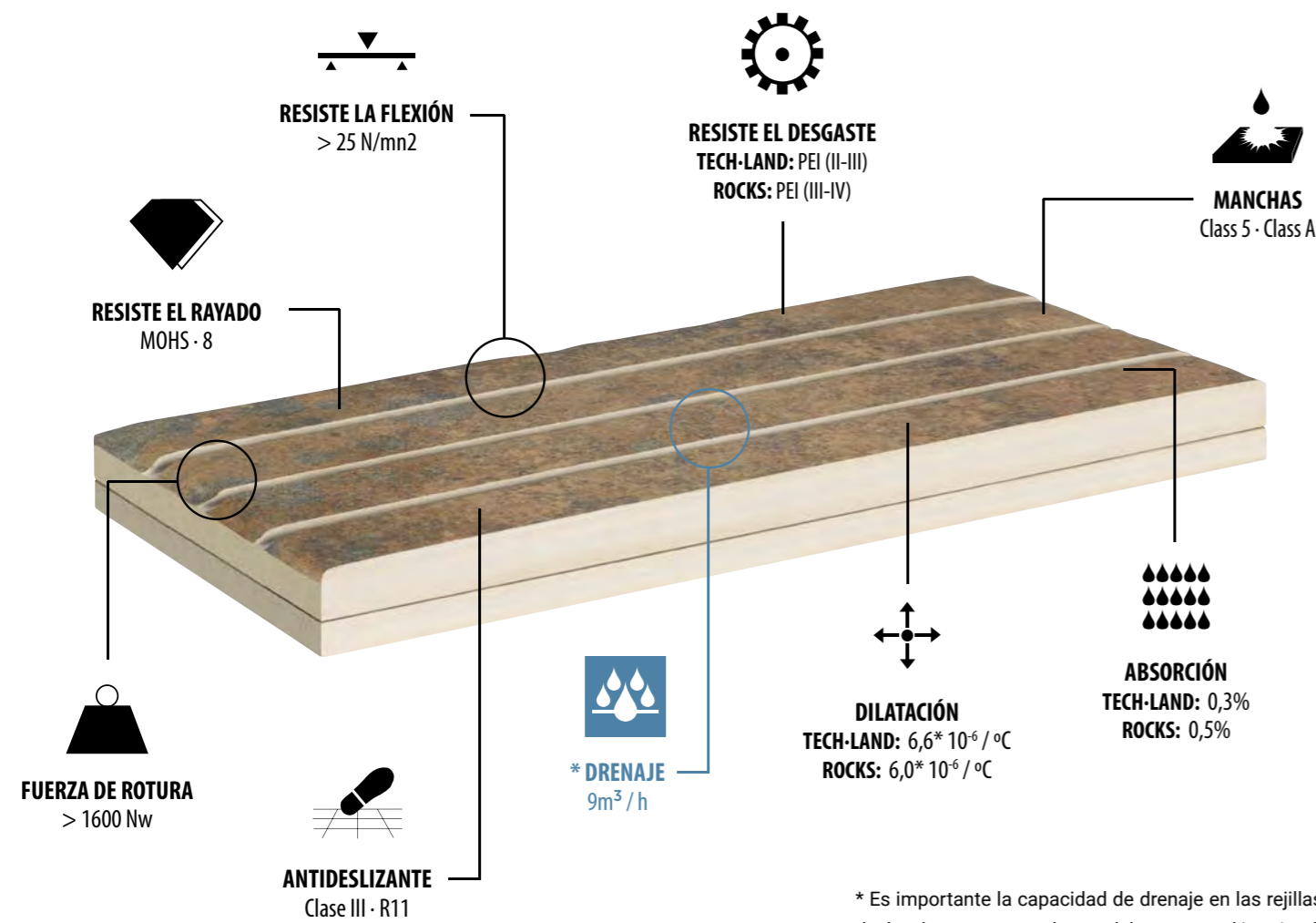

* Es importante la capacidad de drenaje en las rejillas para piscinas desbordantes, ya que el agua debe caer en el interior del canal, nunca inundarlo.
* In overflow system pools, the draining ability is very important, since water will slide into the channel, but never will flood it.

REJILLA TECH-LAND

FUERZA DE ROTURA > 1600 Nw	RESISTE LA FLEXIÓN > 25 N/mn ²	RESISTE EL DESGASTE PEI (II-III)	RESISTE EL RAYADO MOHS - 8	ANTIDESLIZANTE Clase III · R11	ANTID. DCOF. 0,69	ANTID. DIN 51097 Clase C > 37°	MANCHAS Class 5 · Class A	ABSORCIÓN 0,3%	DILATACIÓN 6,6* 10 ⁻⁶ / °C	DRENAJE 9 m ³ /hora

REJILLA ROCKS

FUERZA DE ROTURA > 1600 Nw	RESISTE LA FLEXIÓN > 25 N/mn ²	RESISTE EL DESGASTE PEI (III-IV)	RESISTE EL RAYADO MOHS - 8	ANTIDESLIZANTE Clase III · R11	MANCHAS Class 5 · Class A	ABSORCIÓN 0,5%	DILATACIÓN 6,0* 10 ⁻⁶ / °C	DRENAJE 9 m ³ /hora

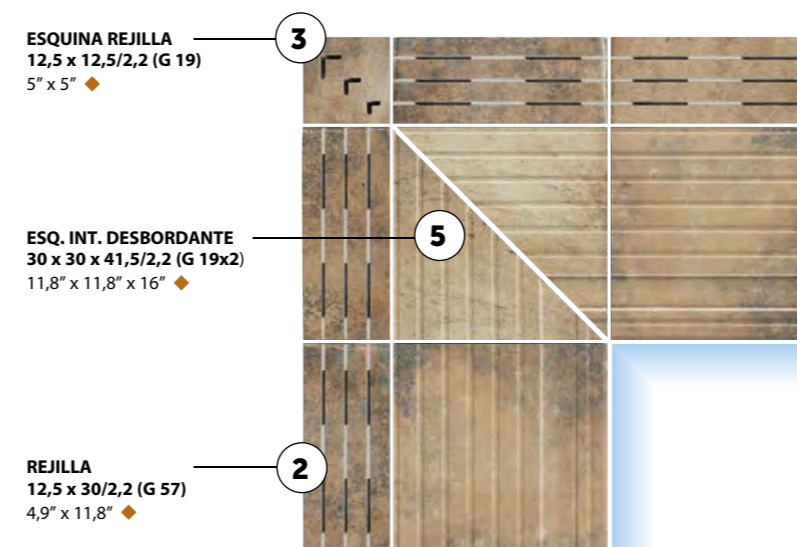
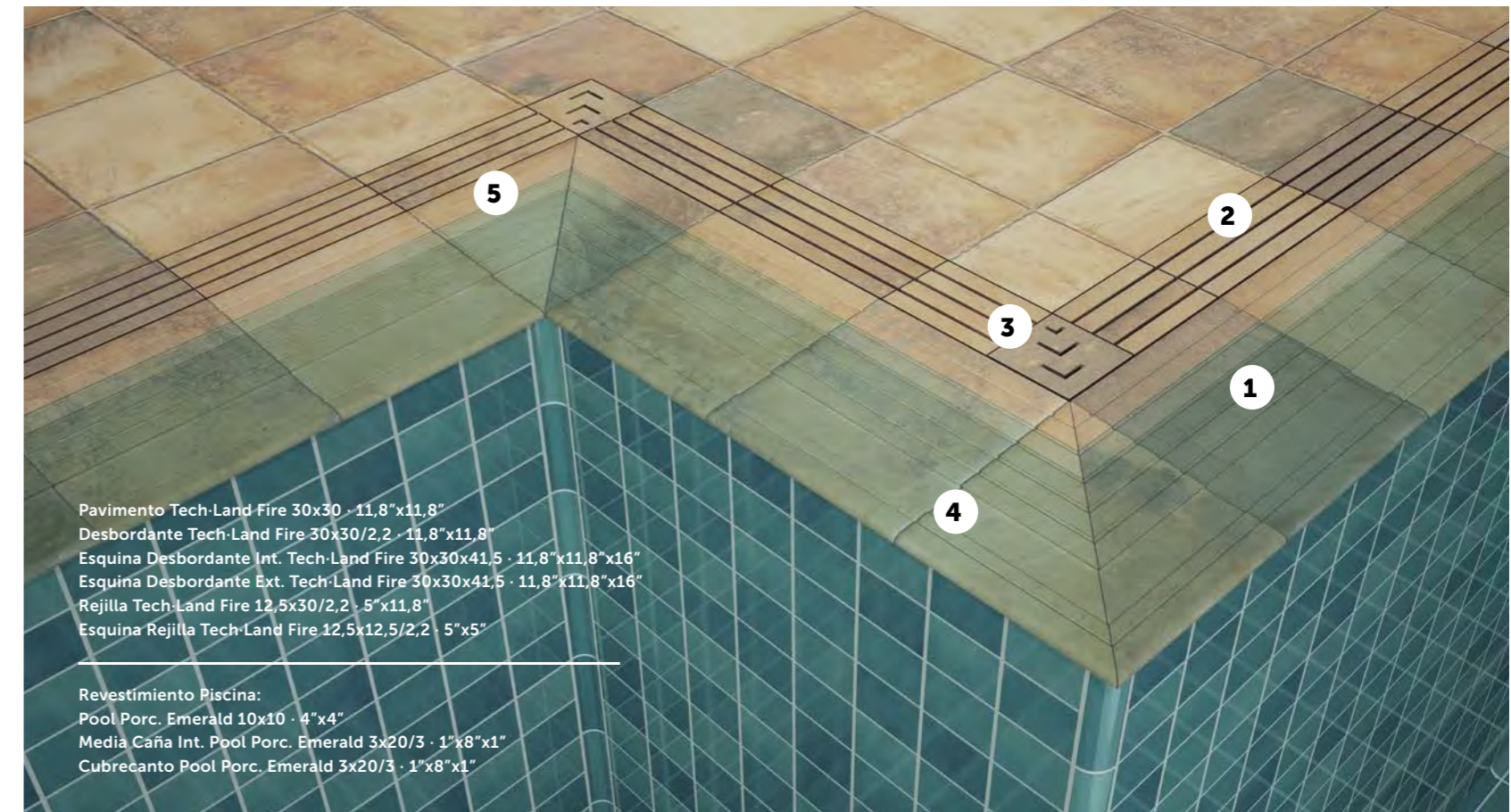

BORDE INTERIOR
INTERIOR EDGE

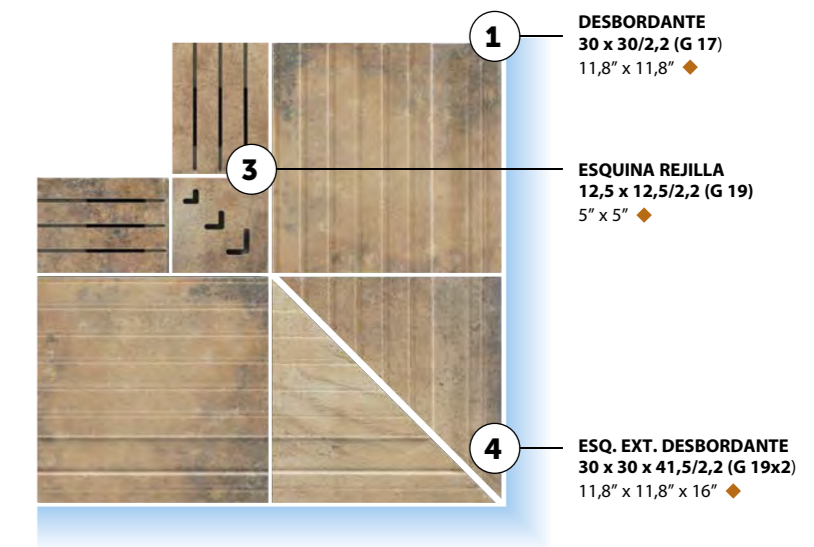

BORDE EXTERIOR
EXTERIOR EDGE

- GRES EXTR. PORCELÁNICO
PORCELAIN EXTRUDED TILE
- DESTONIFICADO ARMONIOSO
CONTROLLED DESTONIFICATION
- RES. A LA HELADA
FROST PROOF
- RES. A ÁCIDOS Y BASES
RES. TO ACIDS AND BASES
- SUPERFICIE MATE
MATT SURFACE
- SIN MANTENIMIENTO
NO MAINTENANCE
- PAV. DE EXTERIOR
OUTDOOR FLOOR TILE

- EVOLUTION
EXTRUDED PORCELAIN TILE
- fine RESISTANCE
- AntiSlip
- AESTHETIC CONTINUITY
POOL & TERRACE DESIGN
- ANTI-BACTERIAL
- IN & OUT



SISTEMA DESBORDANTE OVERFLOW SYSTEM

CANALIZACIÓN CON GRATTING GRATTING CHANNEL

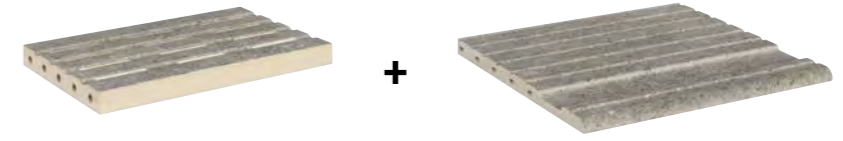

Pavimento Rocks Dark 30x30 · 11,8"x11,8"
Desbordante Rocks Dark 30x30/2,2 · 11,8"x11,8"
Esquina Desbordante Int. Rocks Dark 30x30x41,5 · 11,8"x11,8"x16"
Gratting Rocks Dark 19x30/2,2 · 7"x11,8"
Esquina Gratting Rocks Dark 30x19x25,5 · 11,8"x7"x10"

Revestimiento Piscina:
Pool Porc. Iron 10x10 · 4"x4"
Media Caña Int. Pool Porc. Iron 3x20/3 · 1"x8"x1"
Cubrecanto Pool Porc. Iron 3x20/3 · 1"x8"x1"
Comp. Int. Media Caña Pool Porc. Iron 3x3 · 1"x1"
Comp. Ext. Media Caña Pool Porc. Iron 3x3 · 1"x1"
Comp. Int. Cubrecanto Pool Porc. Iron 3x3 · 1"x1"
Comp. Ext. Cubrecanto Pool Porc. Iron 3x3 · 1"x1"

SISTEMA DESBORDANTE
OVERFLOW SYSTEM

Para conseguir el efecto desbordante se debe instalar una canaleta de filtrado por todo el perímetro de la piscina por dónde el agua entrará de forma constante. Esta canaleta se cubre con nuestras rejillas cerámicas.

In order to get the overflow effect, one filter channel should be installed in all the perimeter of the pool, where water will be constantly flowing. This channel will be covered with our ceramic tile grill.

CANALIZACIÓN CON GRATTING
GRATTING CHANNEL

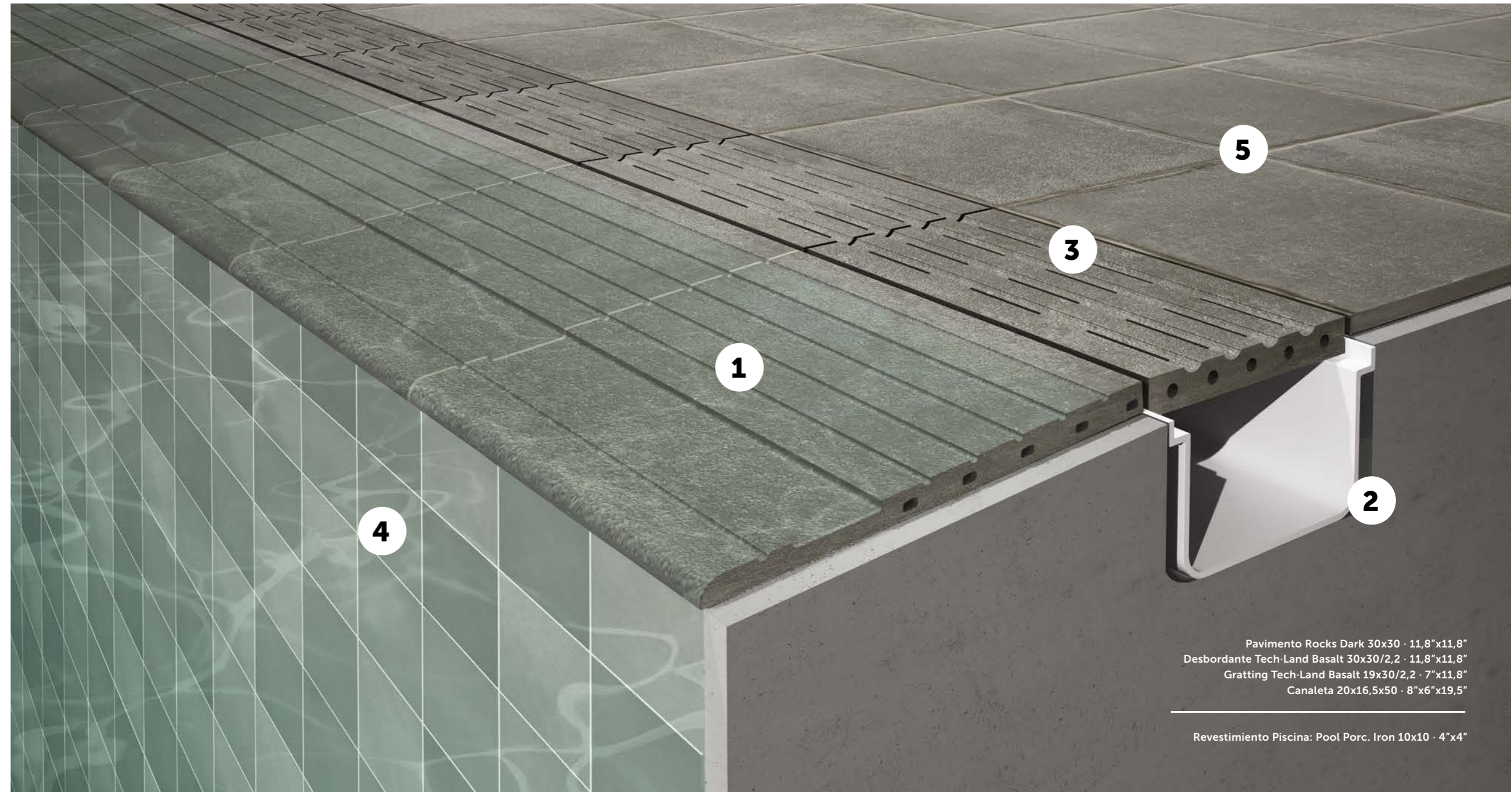
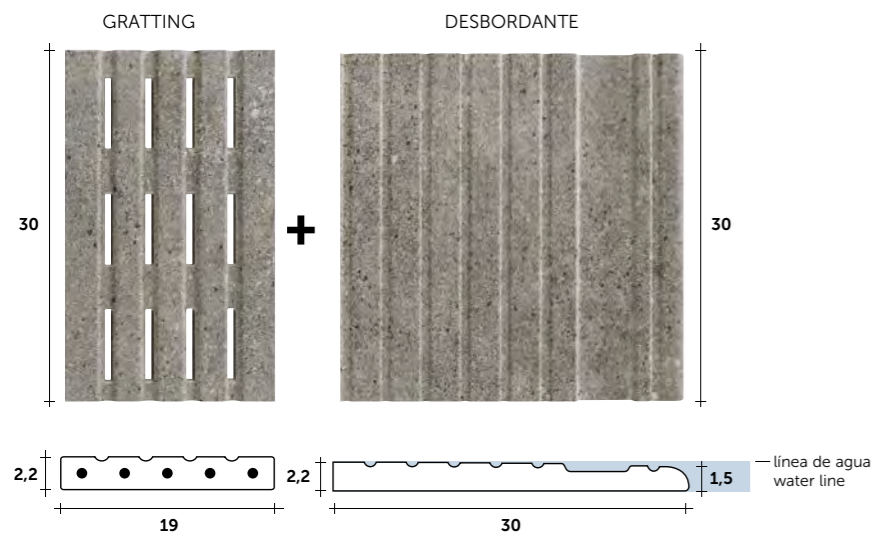

Pavimento Rocks Dark 30x30 · 11,8" x 11,8"
Desbordante Tech-Land Basalt 30x30/2,2 · 11,8" x 11,8"
Gratting Tech-Land Basalt 19x30/2,2 · 7" x 11,8"
Canaleta 20x14,5x50 · 8" x 5,7" x 19,5"

Revestimiento Piscina: Pool Porc. Iron 10x10 · 4" x 4"

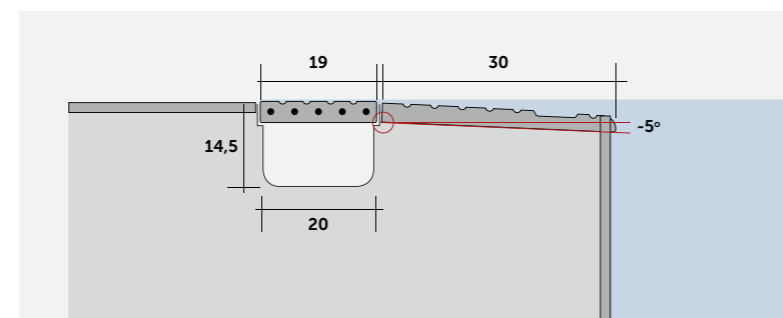

PACKING

FORMATO	PULGADAS	PZ/CAJA	ML	CAJA/PLT	PESO/CAJA	PESO/PLT
30 x 30/2,2 DESBORDANTE	11,8" x 11,8"	7	2,1	44	20,69	930
19 x 30/2,2 GRATTING	7" x 11,8"	6	3,3	56	15	850
20 x 14,5 x 50 CANALETA	8" x 5,7" x 19,5"	12	6	20	10,5	225
30 x 30 x 41,5/2,2 ESQ. EXT. DESBORD.	11,8" x 11,8" x 16"	2	0,6	90	6,3	578
30 x 30 x 41,5/2,2 ESQ. INT. DESBORD.	11,8" x 11,8" x 16"	2	0,6	90	6,3	578
30 x 19 x 25,5/2,2 ESQ. GRATTING	11,8" x 7" x 10"	6	3,3	56	11,4	640

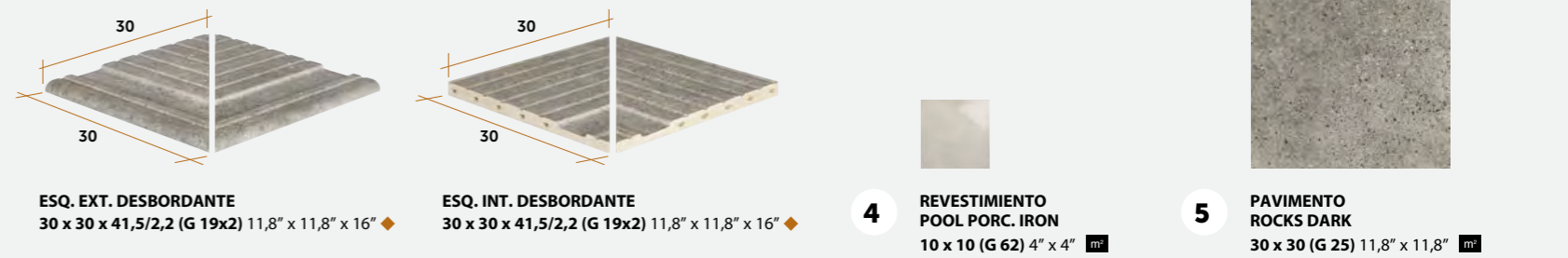

FORMATO	PULGADAS	PZ/CAJA	M ²	CAJA/PLT	PESO/CAJA	PESO/PLT
10 x 10 REVESTIMIENTO	4" x 4"	50	0,5	120	10,5	1.275
30 x 30 PAVIMENTO	11,8" x 11,8"	10	0,90	60	25	1.520

EVOLUTION EXTRUDED PORCELAIN TILE fine RESISTANCE AntiSlip

AESTHETIC CONTINUITY POOL & TERRACE DESIGN ANTI-BACTERIAL IN & OUT

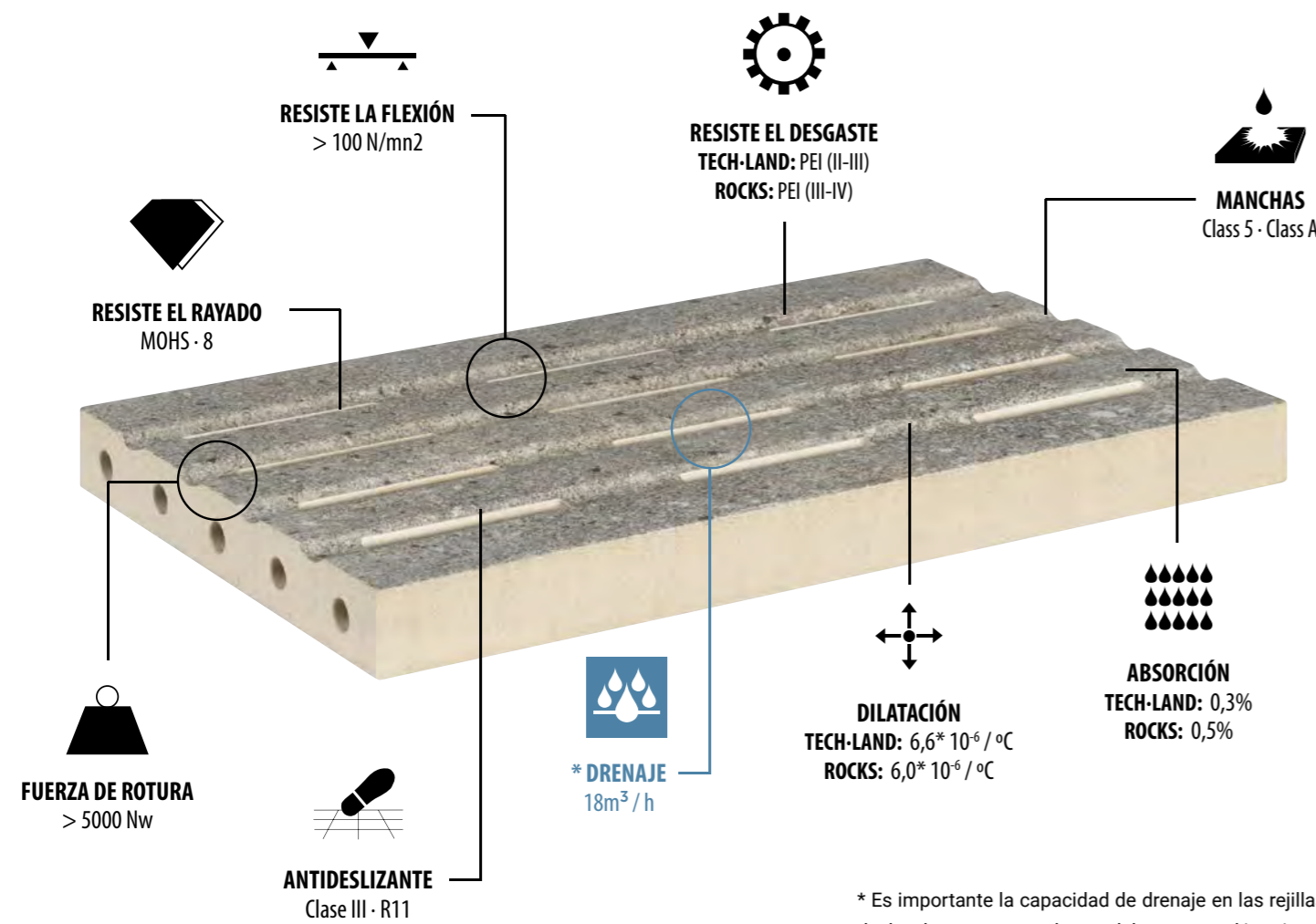

* Es importante la capacidad de drenaje en las rejillas para piscinas desbordantes, ya que el agua debe caer en el interior del canal, nunca inundarlo.
* In overflow system pools, the draining ability is very important, since water will slide into the channel, but never will flood it.

REJILLA TECH-LAND

FUERZA DE ROTURA > 5000 Nw	RESISTE LA FLEXIÓN > 100 N/mn ²	RESISTE EL DESGASTE PEI (II-III)	RESISTE EL RAYADO MOHS - 8	ANTIDESLIZANTE Clase III · R11	ANTID. DCOF. 0,69	ANTID. DIN 51097 Clase C > 37°	MANCHAS Class 5 · Class A	ABSORCIÓN 0,3%	DILATACIÓN 6,6* 10 ⁻⁶ / °C	DRENAJE 18 m ³ /hora
--------------------------------------	--	--	--------------------------------------	--	-----------------------------	--	-------------------------------------	--------------------------	---	---

REJILLA ROCKS

FUERZA DE ROTURA > 5000 Nw	RESISTE LA FLEXIÓN > 100 N/mn ²	RESISTE EL DESGASTE PEI (III-IV)	RESISTE EL RAYADO MOHS - 8	ANTIDESLIZANTE Clase III · R11	MANCHAS Class 5 · Class A	ABSORCIÓN 0,5%	DILATACIÓN 6,0* 10 ⁻⁶ / °C	DRENAJE 18 m ³ /hora
--------------------------------------	--	--	--------------------------------------	--	-------------------------------------	--------------------------	---	---

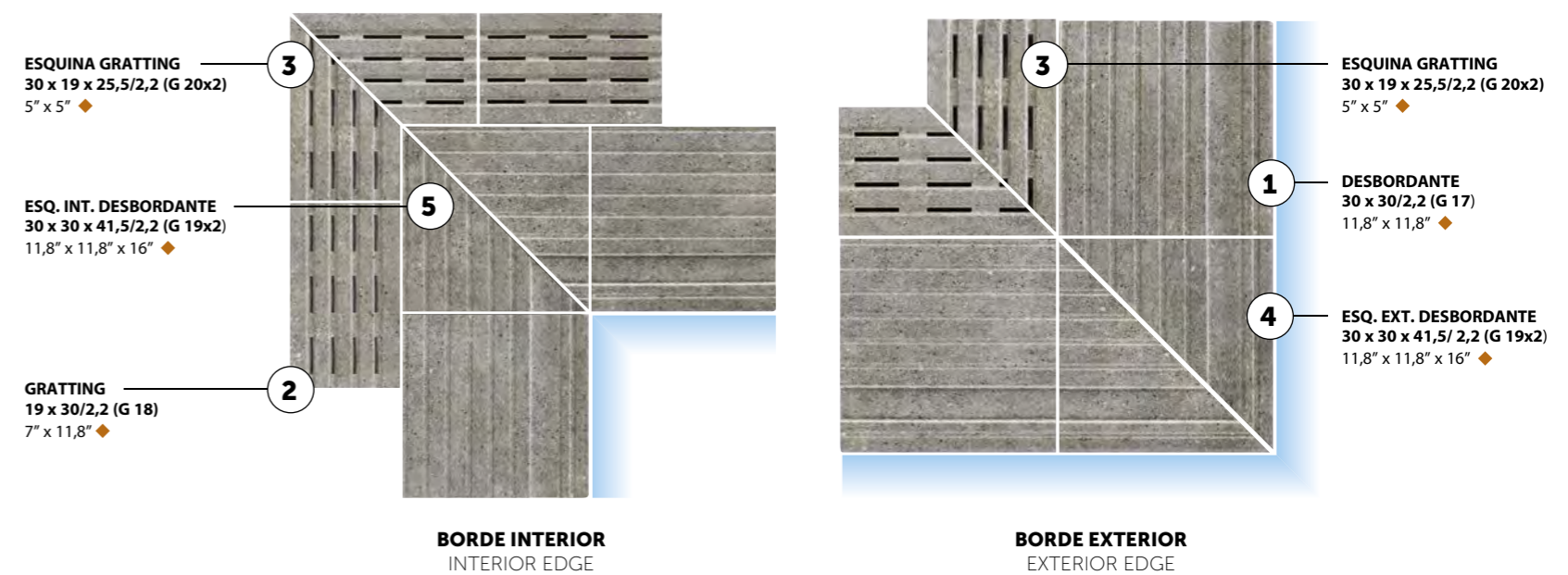
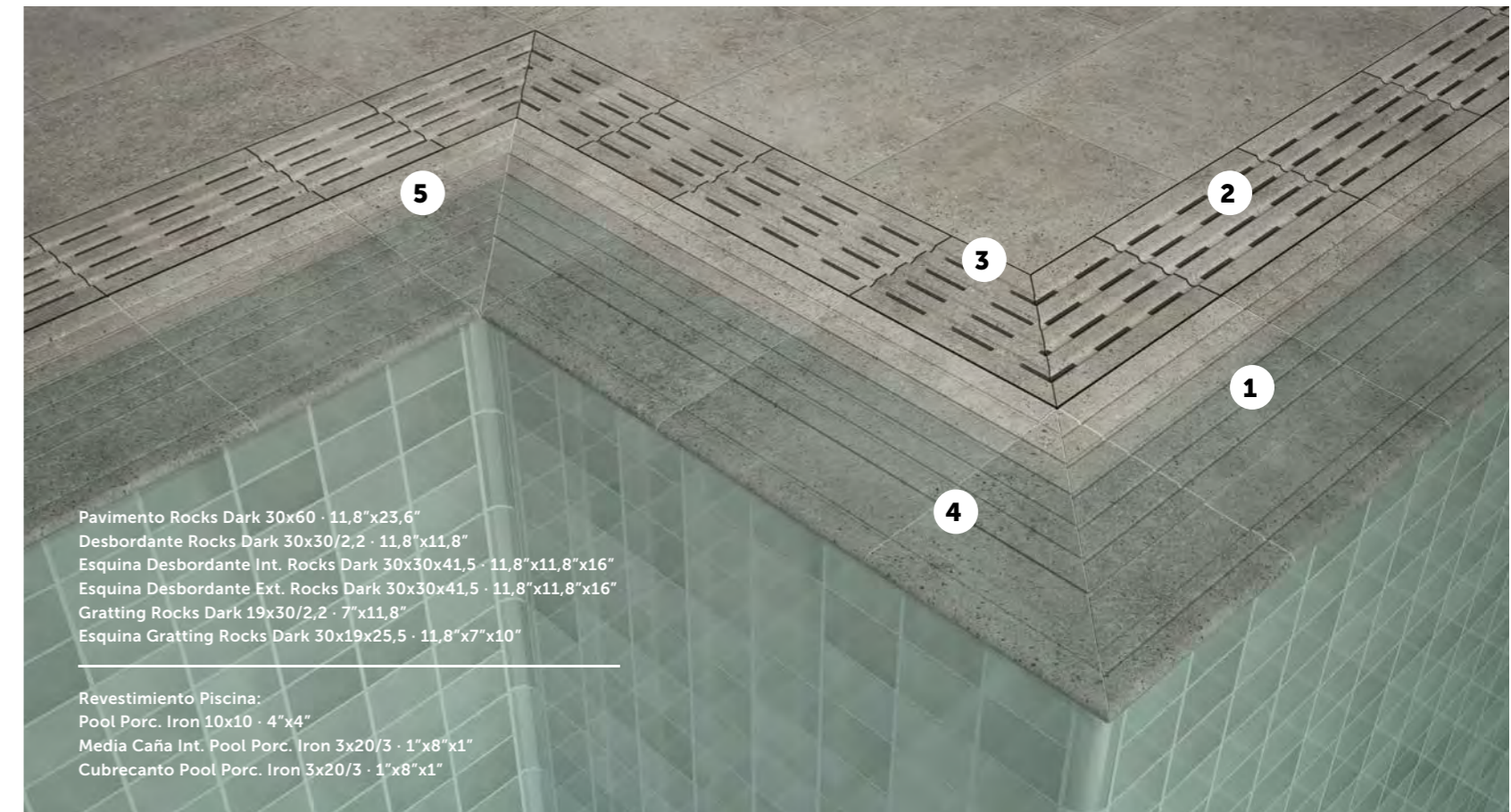

- GRES EXTR. PORCELÁNICO
PORCELAIN EXTRUDED TILE
- DESTONIFICADO ARMONIOSO
CONTROLLED DESTONIFICATION
- RES. A LA HELADA
FROST PROOF
- RES. A ÁCIDOS Y BASES
RES. TO ACIDS AND BASES
- SUPERFICIE MATE
MATT SURFACE
- SIN MANTENIMIENTO
NO MAINTENANCE
- PAV. DE EXTERIOR
OUTDOOR FLOOR TILE







- EVOLUTION
EXTRUDED PORCELAIN TILE
- FINE RESISTANCE
- AntiSlip
- AESTHETIC CONTINUITY
POOL & TERRACE DESIGN
- ANTI-BACTERIAL
- IN & OUT

SISTEMA DESBORDANTE OVERFLOW SYSTEM

COLORES Y ACABADOS DISPONIBLES PARA DESBORDANTE
COLOURS AND FINISHES AVAILABLE FOR OVERFLOW POOL BORDER PIECE

CANALIZACIÓN CON REJILLA
GRILL CHANNEL

CANALIZACIÓN CON GRATTING
GRATTING CHANNEL

COLECCIÓN COLLECTION	FORMATO BASES BASE SIZE	DESBORDANTE 30 x 30/2,2 (G 17) 11,8" x 11,8"	ESQ. EXT. DESBORDANTE 30 x 30 x 41,5/2,2 (G 19x2) 11,8" x 11,8" x 16"	ESQ. INT. DESBORDANTE 30 x 30 x 41,5/2,2 (G 19x2) 11,8" x 11,8" x 16"	REJILLA 12,5 x 30/2,2 (G 57) 4,9" x 11,8" 12,5 x 60/2,2 (G 59) 4,9" x 23,6"	ESQUINA REJILLA 12,5 x 12,5/2,2 (G 19) 5" x 5"	GRATTING 19 x 30/2,2 (G 18) 7" x 11,8"	ESQUINA GRATTING 30 x 19 x 25,5/2,2 (G 20x2) 11,8" x 7" x 10"	
TECH-LAND CLASE III-R11 <small>CLASE C >37° - DCOF 0,69</small> fine RESISTANCE  ANTI-BACTERIAL	11x22,5 (G 39) 4,3"x8,8" <small>m²</small> 22,5x22,5 (G 58) 8,8"x8,8" <small>m²</small> 22,5x33 (G 58) 8,8"x13" <small>m²</small> 30x30 (G 38) 11,8"x11,8" <small>m²</small> HEX. 18x20,5 (G 55) 7"x8" <small>m²</small>	 <p>FIRE NATURE BASALT</p>			REJILLA 12,5 x 30/2,2 · 4,9" x 11,8"		 <p>FIRE NATURE BASALT</p>		
					REJILLA 12,5 x 30/2,2 · 4,9" x 11,8" / REJILLA 12,5 x 60/2,2 · 4,9" x 23,6"				
ROCKS CLASE III-R11 fine RESISTANCE  ANTI-BACTERIAL	36x36 (G 57) 14"x14" <small>m²</small> 30x30 (G 25) 11,8"x11,8" <small>m²</small> 30x60 (G 57) 11,8"x23,6" <small>m²</small>	 <p>WHITE GREY DARK BEIGE BROWN</p>			REJILLA 12,5 x 30/2,2 · 4,9" x 11,8" / REJILLA 12,5 x 60/2,2 · 4,9" x 23,6"		 <p>WHITE GREY DARK BEIGE BROWN</p>		
					 <p>WHITE GREY DARK BEIGE BROWN</p>				



Mayor Antideslizamiento Mayor Suavidad

Los pavimentos de Natucer presentan un acabado especial que elimina la rugosidad característica del producto antideslizante, obteniendo una superficie fina y suave al tacto.

High anti-slippery, High softness

Natucer introduces a special finish avoiding the usual roughness on the anti-slip product, obtaining a flat and soft surface.

TERRACE + POOL WALL IN&OUT SOLUTIONS

Consigue una piscina **100% personalizada**

Las colecciones de Natucer son ideales para cubrir terraza, borde de piscina e incluso el interior de la misma, consiguiendo así un entorno uniforme, lleno de diseño y personal.

Get a **100% customized**

Natucer series are perfect to tile your terrace, swimming pool border, and even the interior of the pool, getting uniform surroundings, full of design and own style.

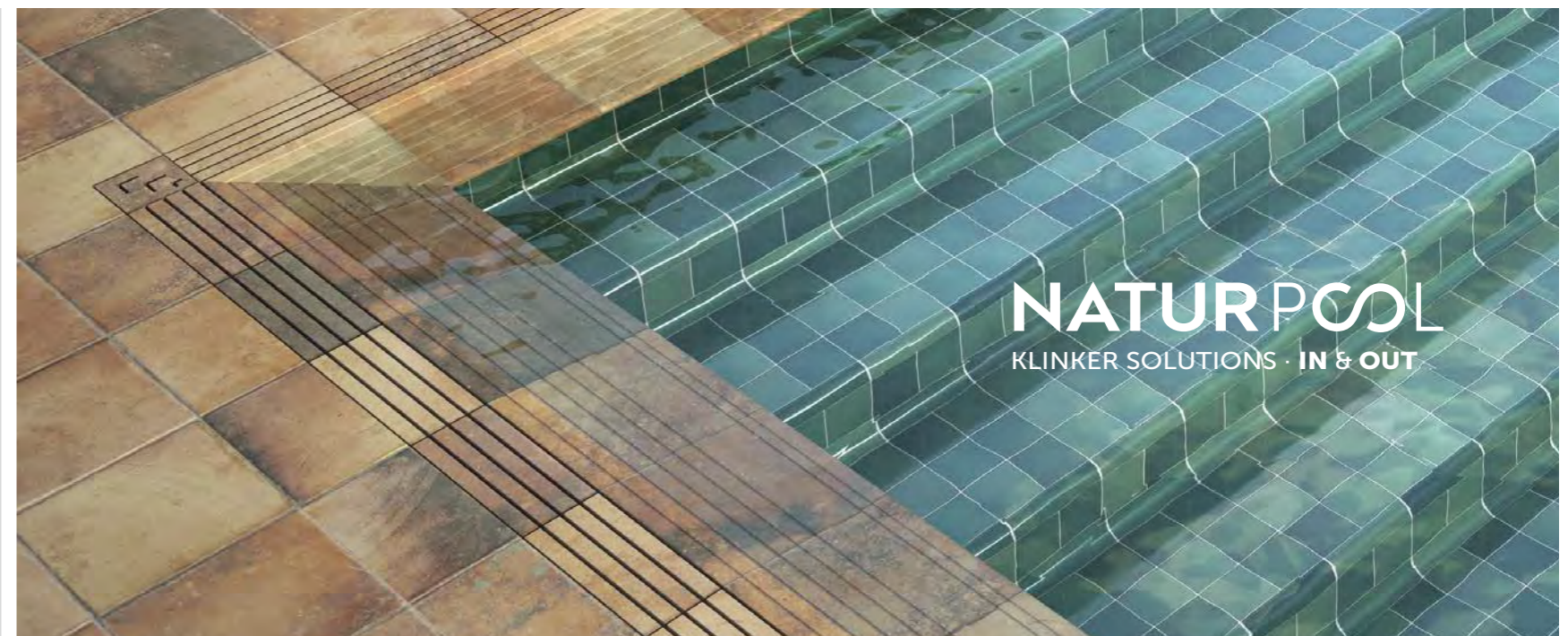

NATURPOOL
KLINKER SOLUTIONS · IN & OUT

SISTEMA INFINITY
INFINITY SYSTEM

Las piscinas Infinity reciben su nombre gracias al efecto óptico que producen, donde el agua se une con el horizonte. Este agua cae a un canal situado en un nivel inferior al del borde. El efecto Infinity puede aplicarse a uno o varios lados del vaso.

Infinity pools get their name due to the optical effect they produce. This neverending surface effect join the water with the horizon. Water falls into the channel, that is installed in a lower level from the surface. Infinity effect can be applied to any of the pool sides.

SOLUCIÓN PARA PISCINA INFINITY CON VIERTEAGUAS
SOLUTION FOR INFINITY POOLS WITH WINDOW RAILS

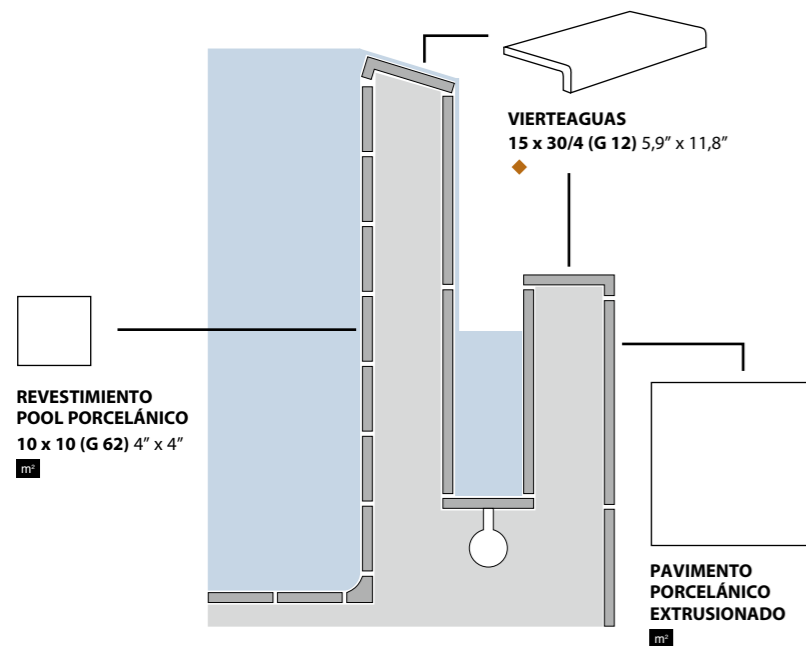

Consigue un gran impacto visual haciendo que tu piscina se pierda en el horizonte.

Get a great visual impact with your pool surface lost in the skyline.

EVOLUTION
EXTRUDED PORCELAIN TILE

fine **RESISTANCE**

AntiSlip

AESTHETIC CONTINUITY
POOL & TERRACE DESIGN

ANTI-BACTERIAL

IN & OUT

Pavimento Rocks White 30x60 · 11,8" x 23,6"
Peldaño Curvo Rocks White 30x33/4 · 11,8" x 13"
Ángulo Peldaño Curvo Rocks White 33x46/4 · 13" x 18"
Frontal Flux 15x32 · 5,9" x 13"

Revestimiento Piscina: Pool Porc. Luz 10x10 · 4" x 4"



Pavimento Rioja Haro 21x60 · 8" x 23,6"
 Peldaño Angular Rioja Haro 120x32x2,5 · 47" x 12,5" x 1"
 Ángulo Peldaño Ang. Rioja Haro 120x32x45/2,5 · 47,2" x 12,6" x 17,7"

Revestimiento Piscina: Pool Porc. Cloud 10x10 · 4" x 4"

NATURPOOL
 KLINKER SOLUTIONS · IN & OUT

SISTEMA **INFINITY**
 INFINITY SYSTEM



Pavimento Grand Canyon Arizona Módulo A
 30x45 · 11,8" x 17,7" · 30x30 · 11,8" x 11,8" · 22,5x45 · 8,8" x 17,7" · 22,5x22,5 · 8,8" x 8,8"
 Peldaño Curvo Grand Canyon Arizona 30x33/4 · 11,8" x 13"



SISTEMA **SKIMMER**
SKIMMER SYSTEM

CORONACIÓN CON BORDE DE PISCINA
CROWNED WITH POOL BORDER TILES



Pavimento Tech Land Natural 11x22,5 - 4,3" x8,8"
Tech Land Natural 22,5x22,5 - 8,8" x8,8"
Tech Land Natural 22,5x33 - 8,8" x13"
Borde Piscina Tech Land Natural 30x36/4 - 11,8" x14"
Esq. Int. Borde Piscina Tech Land Natural 51,2x51,2 - 20,1" x20,1"
Peldaño Curvo Tech Land Natural 30x33/4 - 11,8" x13"

Revestimiento Piscina: Pool Porc. Iron 10x10 - 4" x4"

IN&OUT SOLUTIONS

EXTERIOR PISCINA + REVESTIMIENTO PISCINA

OUTSIDE + INSIDE POOL

Pavimento Rioja Logroño 21x60 - 8" x 23,6"
Borde Piscina Logroño 30x36/4 - 11,8" x 14"
Esq. Int. Borde Piscina Logroño 51,2x51,2 - 20,1" x 20,1"
Peldaño Angular Logroño 32x32/4 - 13" x 13"

Revestimiento piscina: Rioja Logroño 21x60 - 8" x 23,6"



Pavimento Monte Pedra Hex. 36x41,5 - 14"x16,2"
Pavimento Monte Pedra 18,5x42 - 7"x16,4"
Borde Piscina Monte Pedra 30x36/4 - 11,8"x14"
Esq. Ext. Borde Piscina Monte Pedra 51,2x51,2 - 20,1"x20,1"



Pavimento Rocks Brown 30x60 · 11,8" x23,6"
 Borde Piscina Rocks Brown 30x36/4 · 11,8" x14"
 Esq. Int. Borde Piscina Rocks Brown 51,2x51,2 · 20,1" x20,1"

Revestimiento Piscina: Pool Porc. Emerald 10x10 · 4" x4"

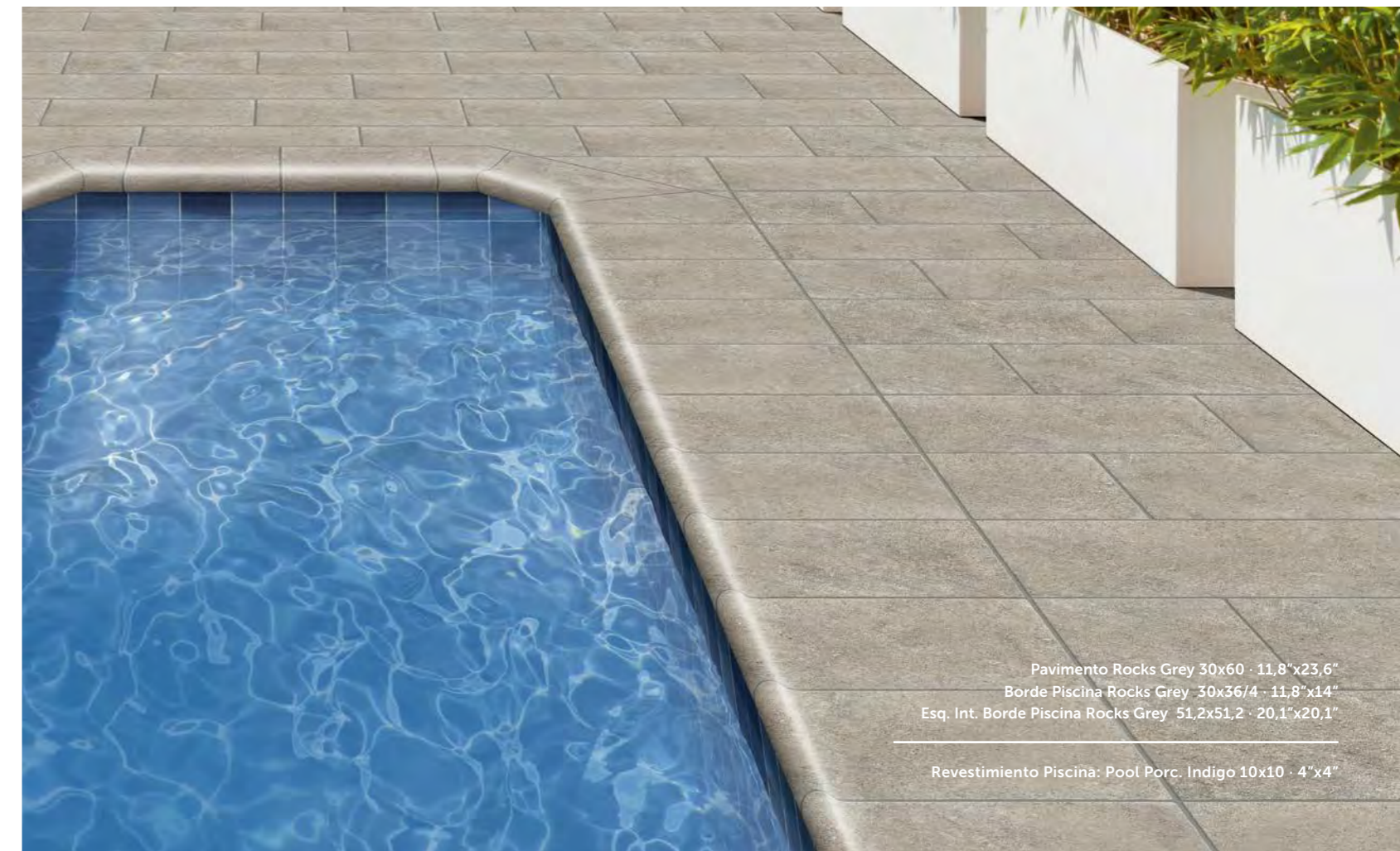

Pavimento Rocks Grey 30x60 · 11,8" x23,6"
 Borde Piscina Rocks Grey 30x36/4 · 11,8" x14"
 Esq. Int. Borde Piscina Rocks Grey 51,2x51,2 · 20,1" x20,1"

Revestimiento Piscina: Pool Porc. Indigo 10x10 · 4" x4"



Pavimento Granite Grosseto Ext. R12 30x30 · 11,8" x11,8"
 Borde Piscina Grosseto Ext. R12 30x36/4 · 11,8" x14"
 Esq. Ext. Borde Piscina Grosseto Ext. R12 51,2x51,2 · 20,1" x20,1"
 Esq. Int. Borde Piscina Grosseto Ext. R12 51,2x51,2 · 20,1" x20,1"
 Revestimiento Granite Carrara Ext. R12 22,5x22,5 · 8,8" x8,8"
 Revestimiento Granite Carrara Ext. R12 22,5x45 · 8,8" x17,7"

Revestimiento Piscina: Pool Porc. Indigo 10x10 · 4" x4"

SISTEMA SKIMMER

SKIMMER SYSTEM

COLORES Y ACABADOS DISPONIBLES PARA BORDE DE PISCINA
COLOURS AND AVAILABLE FINISH FOR POOL BORDER

NATURPOOL
KLINKER SOLUTIONS · IN & OUT

CORONACIÓN CON BORDE DE PISCINA

CROWNED WITH POOL BORDER TILES

El borde de piscina aporta estética, seguridad e higiene. Evita dañarse con los filos o resbalarse cerca de la piscina. Uno de los extremos de la pieza se encuentra en pendiente inversa al agua para evitar la entrada de suciedad a la piscina.

The pool border provides aesthetic style, safety and cleanliness, avoiding damages with edges or sliding near the pool. The back side of the overflow border piece presents an elevation in order to avoid dirt entering into the water.

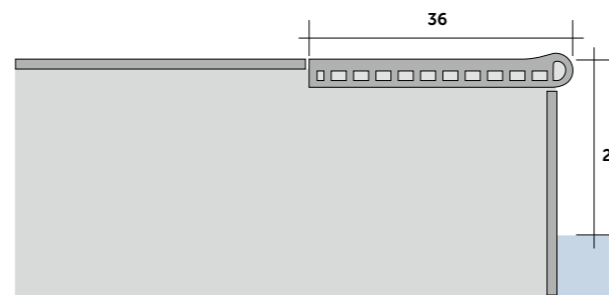
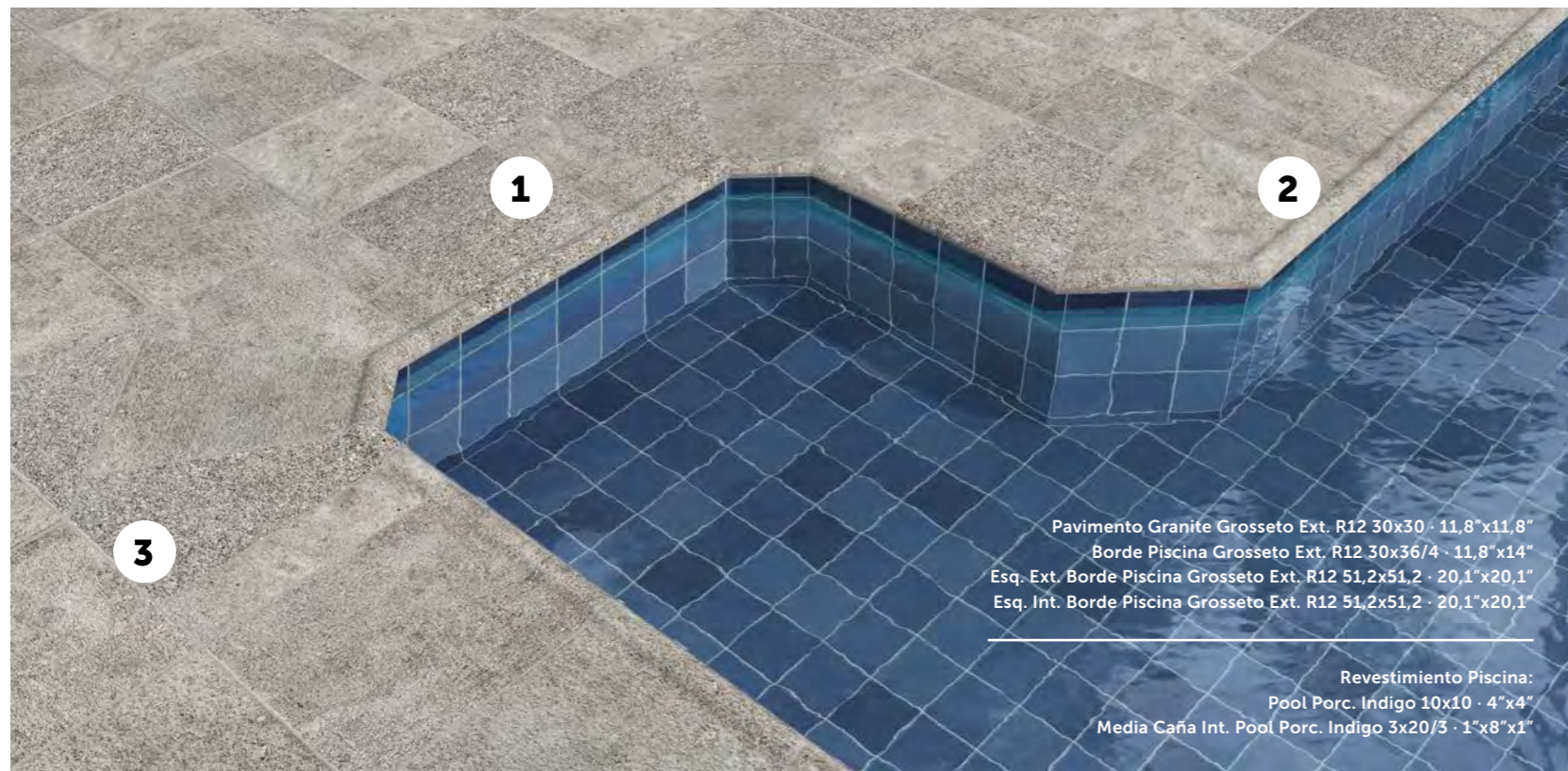
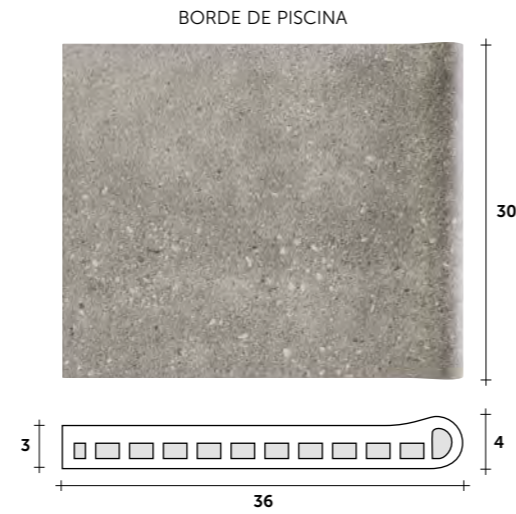

SYSTEMA SKIMMER

El Skimmer se suele colocar a 15 o 20 cm. por debajo del borde de la piscina.

The skimmer should be installed 15 or 20 cm below the pool border.

PACKING

FORMATO	PULGADAS	PZ/CAJA	ML	CAJA/PLT	PESO/CAJA	PESO/PLT
30 x 36/4 BORDE PISCINA	11,8" x 14"	3	0,90	44	15,7	691
51,2 x 51,2 BORDE PISC. ESQ. IN.	20,1" x 20,1"	1	0,51	18	12,71	245
51,2 x 51,2 BORDE PISC. ESQ. EX.	20,1" x 20,1"	1	0,51	18	12,71	245

COLECCIÓN COLLECTION	FORMATO BASES BASE SIZE	BORDE PISCINA 30 x 36/4 (G 19) 11,8" x 14"	BORDE PISCINA ESQ. EXT. 51,2 x 51,2 (G 62 x JUEGO) 20,1" x 20,1"	BORDE PISCINA ESQ. INT. 51,2 x 51,2 (G 62 x JUEGO) 20,1" x 20,1"		
TECH·LAND CLASE III·R11 CLASE C >37° - DCOF 0,69 fine RESISTANCE ANTI-BACTERIAL	11x22,5 (G 39) 4,3"x8,8" m^2 22,5x22,5 (G 58) 8,8"x8,8" m^2 22,5x33 (G 58) 8,8"x13" m^2 30x30 (G 38) 11,8"x11,8" m^2 HEX. 18x20,5 (G 55) 7"x8" m^2					
GRANITE CLASE III·R12 fine RESISTANCE ANTI-BACTERIAL	22,5x22,5 (G 25) 8,8"x8,8" m^2 30x30 (G 25) 11,8"x11,8" m^2 22,5x45 (G 25) 8,8"x17,7" m^2 30x45 (G 57) 11,8"x17,7" m^2					
ROCKS CLASE III·R11 fine RESISTANCE ANTI-BACTERIAL	36x36 (G 57) 14"x14" m^2 30x30 (G 25) 11,8"x11,8" m^2 30x60 (G 57) 11,8"x23,6" m^2					
Rioja CLASE III·R12 fine RESISTANCE	10,5x60 (G 27) 4"x23,6" m^2 21x60 (G 56) 8"x23,6" m^2					
MONTE CLASE III·R11 fine RESISTANCE	10x60 (G 27) 4"x23,6" m^2 30x30 (G 25) 11,8"x11,8" m^2 30x60 (G 38) 11,8"x23,6" m^2 HEX.36x41,5 (G 58) 14"x16,2" m^2 NAVETA 18,5x42 (G 39) 7"x16,4" m^2					

EVOLUTION
EXTRUDED PORCELAIN TILE

fine **RESISTANCE**

AntiSlip

AESTHETIC CONTINUITY
POOL & TERRACE DESIGN

ANTI-BACTERIAL

IN & OUT



SISTEMA **SKIMMER**
SKIMMER SYSTEM

CORONACIÓN CON PELDAÑO 120
CROWNED WITH 120 CM STEP



- Pavimento Rioja Laguardia 21x60 · 8"x23,6"
- Pavimento Rioja Laguardia 10,5x60 · 4"x23,6"
- Peldaño Angular Laguardia 120x32x2,5 · 47"x12,5" x1"
- Remate Peldaño Curvo Laguardia 2,5x32 · 1"x12,5"
- Zócalo Laguardia 9x30 · 3,5"x11,8"
- Zanquín 2,5 DRCH. Laguardia 9x30 · 3,5"x11,8"
- Frontal Wood 15,5x30 · 6"x11,8"

CORONACIÓN CON PELDAÑO 120
CROWNED WITH 120 CM STEP

Una solución de coronación de piscina totalmente actual son los peldaños de gran formato, recto o curvo. Aportan diseño y funcionalidad, ya que se evitan cortes y juntas innecesarias.

A new crowning solution for modern pools is the large sized steps, angular or curved. They are functional as well as full of design, avoiding cuts and unneeded joints.

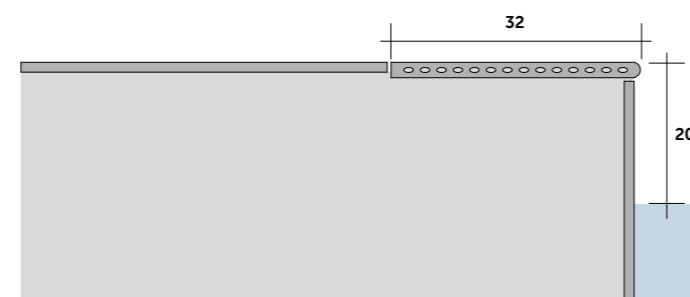

PACKING

FORMATO	PULGADAS	PZ/CAJA	ML	CAJA/PLT	PESO/CAJA	PESO/PLT
120 x 32 x 2,5 PELDAÑO ANG.	47" x 12,5" x 1"	2	2,4	14	36,7	530
60 x 32 x 2,5 PELDAÑO ANG.	23,6" x 12,5" x 1"	2	1,2	28	18,9	542
120 x 32 x 45 ANG. PELDAÑO 120 INT.	47" x 12,5" x 17,7"	2	2,4	14	32	450
120 x 32 x 45 ANG. PELDAÑO 120 EXT.	47" x 12,5" x 17,7"	2	2,4	14	32	450

PELDAÑO CURVO
120 x 32/2,5 (G 42) 47" x 12,5" x 1" ♦
60 x 32/2,5 (G 57) 23,6" x 12,5" x 1" ♦
BOSTON · FERRO DI BOSTON

COLECCIÓN COLLECTION	FORMATO BASES BASE SIZE	PELDAÑO 120 ANGULAR / CURVO 120 x 32 / 2,5 (G 42) 47,2" x 12,6" / 1" ♦ 60 x 32 / 2,5 (G 57) 23,6" x 12,6" / 1" ♦	ÁNGULO PELDAÑO 120. INT 120 x 32 x 45 / 2,5 (G 46 x 2) 47,2" x 12,6" x 17,7" / 1" ♦	ÁNGULO PELDAÑO 120. EXT 120 x 32 x 45 / 2,5 (G 46 x 2) 47,2" x 12,6" x 17,7" / 1" ♦
CLASE III-R12 fine RESISTANCE	10,5x60 (G 27) 4"x23,6" m ² 21x60 (G 56) 8"x23,6" m ²	PELDAÑO ANGULAR 120 120 x 32/2,5 · 47,2" x 12,6"/1" · 60 x 32/2,5 · 23,6" x 12,6"/1"		
MONTE CLASE III-R11 fine RESISTANCE	10x60 (G 27) 4"x23,6" m ² 30x30 (G 25) 11,8"x11,8" m ² 30x60 (G 38) 11,8"x23,6" m ² HEX. 36x41,5 (G 58) 14"x16,2" m ² NAVETA 18,5x42 (G 39) 7"x16,4" m ²	PELDAÑO ANGULAR 120 120 x 32/2,5 · 47,2" x 12,6"/1" · 60 x 32/2,5 · 23,6" x 12,6"/1"		
D'Anticatto CLASE III-R11 DIN 51097: CLASE C >38" fine RESISTANCE	11x22,5 (G57) · 4,3"x8,8" m ² 22,5x22,5 (G25) · 8,8"x8,8" m ² 22,5x45 (G25) · 8,8"x17,7" m ²	PELDAÑO ANGULAR 120 120 x 32/2,5 · 47,2" x 12,6"/1" · 60 x 32/2,5 · 23,6" x 12,6"/1"		
CLASE III-R11 fine RESISTANCE	11x22,5 (G57) · 4,3"x8,8" m ² 22,5x22,5 (G25) · 8,8"x8,8" m ² 22,5x45 (G25) · 8,8"x17,7" m ² 36x36 (G57) · 14"x14" m ² HEX. 36x41,5 (G58) · 14"x16,2" m ² HEX. 28,5x32,5 (G39) · 11,2"x12,7" m ²	PELDAÑO CURVO 120 120 x 32/2,5 · 47,2" x 12,6"/1" · 60 x 32/2,5 · 23,6" x 12,6"/1"		
FERRO di BOSTON CLASE III-R11 fine RESISTANCE	15x30 (G25) · 5,9"x11,8" m ² 36x36 (G57) · 14"x14" m ² HEX 36x41,5 (G58) · 14"x16,2" m ² NAVETA 18,5x42 (G39) · 7"x16,4" m ²	PELDAÑO CURVO 120 120 x 32/2,5 · 47,2" x 12,6"/1" · 60 x 32/2,5 · 23,6" x 12,6"/1"		

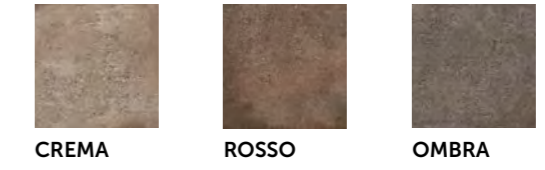
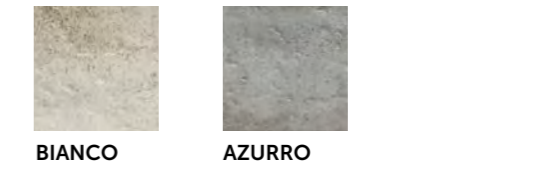
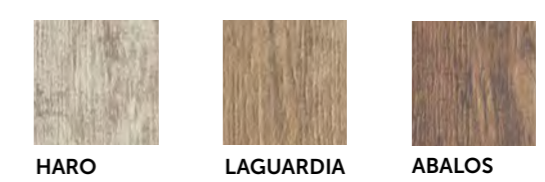



SISTEMA **SKIMMER**
SKIMMER SYSTEM

CORONACIÓN CON:
CROWNED WITH:



PELDAÑO CURVO



PELDAÑO ANGULAR



VIERTEGUAS



IN&OUT SOLUTIONS
EXTERIOR PISCINA + REVESTIMIENTO PISCINA
OUTSIDE + INSIDE POOL

Pavimento Tech Geo Volcano 22,5x33 · 8,8" x13"
Pavimento Tech Geo Volcano 22,5x22,5 · 8,8" x8,8"
Pavimento Tech Geo Volcano 11x22,5 · 4,3" x8,8"
Peldaño Curvo Tech Geo Volcano 22,5x33/4 · 8,8" x13"

Revestimiento Piscina Tech Geo Volcano 11x22,5 · 4,3" x8,8"



Pavimento Pietra di Firenze Nero 30x60 · 11,8" x 23,6"
Pavimento Pietra di Firenze Nero 30x30 · 11,8" x 11,8"
Revestimiento Pietra di Firenze Albino 30x60 · 11,8" x 23,6"
Peldaño Curvo Albino 30x33/4 · 11,8" x 13"
Peldaño Curvo Nero 30x33/4 · 11,8" x 13"
Decor Frontal Flux 15x32 · 5,9" x 13"

Revestimiento Piscina: Pool Porc. Indigo 10x10 · 4" x 4"

NATURPOOL
KLINKER SOLUTIONS · IN & OUT

SISTEMA **SKIMMER**
SKIMMER SYSTEM



Pavimento Rocks White 30x60 · 11,8" x 23,6"
Peldaño Curvo Rocks White 30x33/4 · 11,8" x 13"

Revestimiento Piscina: Pool Porc. Cloud 10x10 · 4" x 4"

SISTEMA SKIMMER
SKIMMER SYSTEM

Para la coronación de este sistema tradicional encontramos varias opciones que se adaptan a cada necesidad constructiva.

We offer different options for the pool crowning system, depending on each building need.

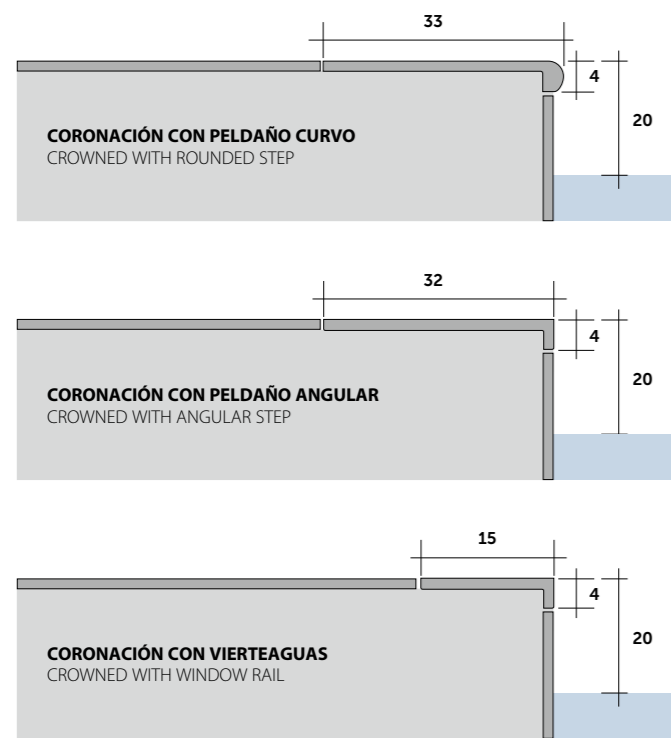

El Skimmer se suele colocar a 15 o 20 cm. por debajo del borde de la piscina.
The skimmer should be installed 15 or 20 cm below the pool border.

EVOLUTION
EXTRUDED PORCELAIN TILE

fine **RESISTANCE**

AntiSlip

AESTHETIC CONTINUITY
POOL & TERRACE DESIGN

ANTI-BACTERIAL

IN & OUT

NATUCER



Pavimento Boston Downtown 22,5x45 - 8,8"x17,7"
Vierteaguas Boston Downtown 15x22,5/4 - 5,9"x8,8"

Revestimiento Piscina: Boston Downtown 22,5x45 - 8,8"x17,7"

PACKING

FORMATO	PULGADAS	PZ/CAJA	ML	CAJA/PLT	PESO/CAJA	PESO/PLT
15 x 30/4 VIERTEAGUAS	5,9" x 11,8"	14	4,2	48	15,08	738
15 x 22,5/4 VIERTEAGUAS	5,9" x 8,8"	14	3,15	48	15,08	739
30 x 33/4 PELDAÑO CURVO	11,8" x 13"	4	1,2	54	11,90	660
22,5 x 33/4 PELDAÑO CURVO	8,8" x 13"	6	1,35	54	12	665
36 x 33/4 PELDAÑO CURVO	14" x 13"	4	1,44	54	13,4	740
32 x 32/4 PELDAÑO ANGULAR	13" x 13"	4	1,25	54	11,90	660
33 x 33/4 ÁNGULO PELDAÑO CURV. 1PZ	13" x 13"	1	0,33	90	3,7	333
33 x 46/4 ÁNGULO PELDAÑO CURV.	13" x 18"	2	0,33	90	3,46	325
32 x 46/4 ÁNGULO PELDAÑO ANG.	13" x 18"	2	0,32	90	3,46	308

FORMATO	PULGADAS	PZ/CAJA	M ²	CAJA/PLT	PESO/CAJA	PESO/PLT
22,5 x 45 PAVIMENTO	8,8" x 17,7"	10	1,01	72	21,1	1.530

FORMATOS DISPONIBLES **SEGÚN COLECCIÓN**
AVAILABLE FORMATS DEPENDING ON SERIES

1 **VIERTEAGUAS**
15 x 30 / 4 (G 12) 5,9" x 11,8" ♦
15 x 22,5 / 4 (G 10) 5,9" x 8,8" ♦

PELDAÑO CURVO
30 x 33 / 4 (G 17) 11,8" x 13" ♦
22,5 x 33 / 4 (G 16) 8,8" x 13" ♦
36 x 33 / 4 (G 18) 14" x 13" ♦

PELDAÑO ANGULAR
32 x 32 / 4 (G 17) 13" x 13" ♦

ÁNGULO PELDAÑO CURVO 1PZ.
33 x 33 / 4 (G 56) 13" x 13" ♦















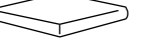

















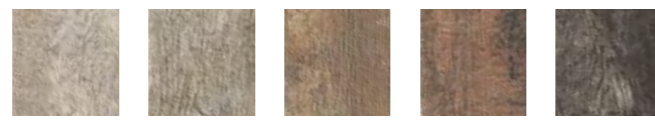
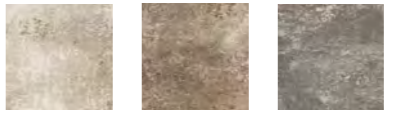
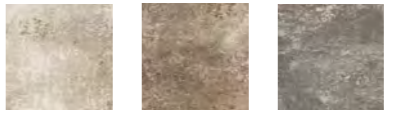

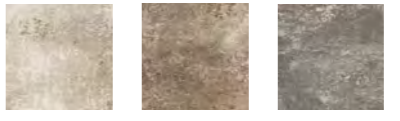

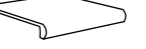
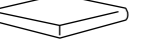

ÁNGULO PELDAÑO CURVO
33 x 46 / 4 (G 19x2) 13" x 18" ♦

ÁNGULO PELDAÑO ANGULAR
32 x 46 / 4 (G 18 x 2) 13" x 18" ♦

2 **PAVIMENTO BOSTON DOWNTOWN**
22,5 x 45 (G 25) 8,8" x 17,7" m

SISTEMA **SKIMMER**
SKIMMER SYSTEM

COLORES Y ACABADOS DISPONIBLES PARA PELDAÑO CURVO, PELDAÑO ANGULAR Y VIERTEAGUAS
COLOURS AND AVAILABLE FINISH FOR ROUNDED STEP, ANGLE STEP AND WINDOW RAIL

COLECCIÓN COLLECTION	FORMATO BASES BASE SIZE	 PELDAÑO CURVO 22,5x33/4 (G 16) 8,8"x13" ♦ 30x33/4 (G 17) 11,8"x13" ♦ 36x33/4 (G 18) 14"x13" ♦	 ÁNGULO PELDAÑO CUR. 33x46/4 (G 19x2) 13"x18" ♦	 VIERTEAGUAS 15x30/4 (G 12) 5,9"x11,8" ♦ 15x22,5/4 (G 10) 5,9"x 8,8" ♦	COLECCIÓN COLLECTION	FORMATO BASES BASE SIZE	 PELDAÑO CURVO 22,5x33/4 (G 16) 8,8"x13" ♦ 30x33/4 (G 17) 11,8"x13" ♦ 36x33/4 (G 18) 14"x13" ♦	 ÁNGULO PELDAÑO CUR. 1PZ. 33x33/4 (G 56) 13"x13" ♦	 VIERTEAGUAS 15x30/4 (G 12) 5,9"x11,8" ♦ 15x22,5/4 (G 10) 5,9"x 8,8" ♦	
ROCKS CLASE III-R11 fine RESISTANCE  ANTI-BACTERIAL	36x36 (G 57) 14"x14" m² 30x30 (G 25) 11,8"x11,8" m² 30x60 (G 57) 11,8"x23,6" m²	PELDAÑO CURVO 30x33/4 · 11,8"x13" · 36x33/4 · 14"x13" VIERTEAGUAS 15x30/4 · 5,9"x11,8"			TECH-LAND CLASE III-R11 CLASE C >37° · DCOF 0,69 fine RESISTANCE  ANTI-BACTERIAL	11x22,5 (G 39) 4,3"x8,8" m² 22,5x22,5 (G 58) 8,8"x8,8" m² 22,5x33 (G 58) 8,8"x13" m² 30x30 (G 38) 11,8"x11,8" m² HEX. 18x20,5 (G 55) 7"x8" m²	PELDAÑO CURVO 30x33/4 · 11,8"x13" VIERTEAGUAS 15x30/4 · 5,9"x11,8"			 FIRE NATURE BASALT
		 WHITE GREY DARK BEIGE BROWN					 CARRARA LIVORNO GROSSETO CALABRIA EMPOLI			
GRANITE CLASE III-R12 fine RESISTANCE	22,5x22,5 (G 25) 8,8"x8,8" m² 30x30 (G 25) 11,8"x11,8" m² 22,5x45 (G 25) 8,8"x17,7" m² 30x45 (G 57) 11,8"x17,7" m²	PELDAÑO CURVO 30x33/4 · 11,8"x13" VIERTEAGUAS 15x30/4 · 5,9"x11,8" · 15x22,5/4 · 5,9"x8,8"			MONTE CLASE III-R11 fine RESISTANCE	10x60 (G 27) 4"x23,6" m² 30x30 (G 25) 11,8"x11,8" m² 30x60 (G 38) 11,8"x23,6" m² HEX. 36x41,5 (G 58) 14"x16,2" m² NAVETA 18,5x42 (G 39) 7"x16,4" m²	PELDAÑO CURVO 30x33/4 · 11,8"x13" VIERTEAGUAS 15x30/4 · 5,9"x11,8"			 BLAT CANYELLA TORTOLA PEDRA
		 ALBINO NOCCIOLA GIADA NEBBIA NERO					 DOWNTOWN EAST NORTH SOUTH WEST			
 CLASE III-R12 fine RESISTANCE	30x30 (G25) · 11,8"x11,8" m² 30x60 (G56) · 11,8"x23,6" m²	PELDAÑO CURVO 30x33/4 · 11,8"x13" VIERTEAGUAS 15x30/4 · 5,9"x11,8"			 CLASE III-R11 fine RESISTANCE	11x22,5 (G57) · 4,3"x8,8" m² 22,5x22,5 (G25) · 8,8"x8,8" m² 22,5x45 (G25) · 8,8"x17,7" m² 36x36 (G57) · 14"x14" m² HEX. 36x41,5 (G58) · 14"x16,2" m² HEX. 28,5x32,5 (G39) · 11,2"x12,7" m²	PELDAÑO CURVO 22,5x33/4 · 8,8"x13" · 36x33/4 · 14"x13" VIERTEAGUAS 15x22,5/4 · 5,9"x8,8"			 DOWNTOWN EAST NORTH SOUTH WEST
		 ALBINO NOCCIOLA GIADA NEBBIA NERO					 BIANCO CREMA ROSSO OMBRA			
COLECCIÓN COLLECTION	FORMATO BASES BASE SIZE	 PELDAÑO ANGULAR 32x32/4 (G 17) 13"x13" ♦	 ÁNGULO PELDAÑO ANG. 32x46/4 (G 18x2) 13"x18" ♦	FERRO di BOSTON CLASE III-R11 fine RESISTANCE	15x30 (G25) · 5,9"x11,8" m² 36x36 (G57) · 14"x14" m² HEX 36x41,5 (G58) · 14"x16,2" m² NAVETA 18,5x42 (G39) · 7"x16,4" m²	PELDAÑO CURVO 36x33/4 · 14"x13" VIERTEAGUAS 15x30/4 · 5,9"x11,8"			 BIANCO CREMA ROSSO OMBRA	
		 ASPEN WILLOW NUT CHERRY TEAK				 NEVADA ARIZONA UTHA				
TECH · RAIL CLASE III-R11 fine RESISTANCE	21x60 (G58) · 8"x23,6" m²	PELDAÑO CURVO 30x33/4 · 11,8"x13" VIERTEAGUAS 15x30/4 · 5,9"x11,8" · 15x22,5/4 · 5,9"x8,8"			GRAND CANYON CLASE III-R13 fine RESISTANCE	22,5x22,5 (G25) · 8,8"x8,8" m² 22,5x45 (G25) · 8,8"x17,7" m² 30x45 (G57) · 11,8"x17,7" m² 30x30 (G25) · 11,8"x11,8" m²	PELDAÑO CURVO 30x33/4 · 11,8"x13" VIERTEAGUAS 15x30/4 · 5,9"x11,8" · 15x22,5/4 · 5,9"x8,8"			 NEVADA ARIZONA UTHA
		 HARO LOGROÑO BRIONES LAGUARDIA ABALOS NAJERA					 NEVADA ARIZONA UTHA			
 CLASE III-R12 fine RESISTANCE	10,5x60 (G 27) 4"x23,6" m² 21x60 (G 56) 8"x23,6" m²	PELDAÑO CURVO 22,5x33/4 (G 16) 8,8"x13" ♦			COLECCIÓN COLLECTION	FORMATO BASES BASE SIZE	 PELDAÑO CURVO 22,5x33/4 (G 16) 8,8"x13" ♦	 ÁNGULO PELDAÑO CUR. 1PZ. 33x33/4 (G 56) 13"x13" ♦	 BIANCO MARRONE GRIGIO AZURRO MUSCHIO NOTTE	
		 BLANC TERRA CENDRA NEGRE					 BIANCO MARRONE GRIGIO AZURRO MUSCHIO NOTTE			
RETRO CLASE III-R11 fine RESISTANCE	7x60 (G27) · 3"x23,6" m² 21x60 (G38) · 8"x23,6" m² HEX. 36x41,5 (G58) · 14"x16,2" m² NAVETA 18,5x42 (G39) · 7"x16,4" m²	PELDAÑO CURVO 22,5x33/4 (G 16) 8,8"x13" ♦			TECH · GEO CLASE III-R11 fine RESISTANCE	11x22,5 (G39) · 4,3"x8,8" m² 22,5x22,5 (G58) · 8,8"x8,8" m² 22,5x33 (G58) · 8,8"x13" m²	PELDAÑO CURVO 22,5x33/4 (G 16) 8,8"x13" ♦			 GLACIER RIVER MOUNTAIN VOLCANO
		 BLANC TERRA CENDRA NEGRE					 GLACIER RIVER MOUNTAIN VOLCANO			
 EVOLUTION EXTRUDED PORCELAIN TILE	fine RESISTANCE	 AntiSlip	 AESTHETIC CONTINUITY POOL & TERRACE DESIGN	 ANTI-BACTERIAL	 IN & OUT	D'Anticatto CLASE III-R11 DIN 51097 · CLASE C >38° fine RESISTANCE	11x22,5 (G57) · 4,3"x8,8" m² 22,5x22,5 (G25) · 8,8"x8,8" m² 22,5x45 (G25) · 8,8"x17,7" m²	 BIANCO MARRONE GRIGIO AZURRO MUSCHIO NOTTE		



REVESTIMIENTO **POOL PORC.**
POOL PORC. TILE

REVESTIMIENTO ESPECIAL PARA VASO DE PISCINA
SPECIAL REVESTMENT FOR THE INTERIOR OF THE POOL



Pavimento Rocks Grey 30x30 · 11,8" x 11,8"
Borde Piscina Rocks Grey 30x36/4 · 11,8" x 14"
Esq. Int. Borde Piscina Rocks Grey 51,2 x 51,2 · 20,1" x 20,1"

Revestimiento Piscina:
Pool Porc. Indigo 10x10 · 4" x 4"
Media Caña Int. Pool Porc. Indigo 3x20/3 · 1" x 8" x 1"
Complemento Int. Media Caña Pool Porc. Indigo 3x3 · 1" x 1"

4 RAZONES PARA REVESTIR LA PISCINA CON POOL PORC.

4 REASONS TO TILE THE POOL WITH POOL PORC.

- 1** Resistente a la luz, a la humedad, al desgaste y a deformaciones. Inalterable al paso del tiempo.
Resist light, humidity, wear and deformation. Standing the test of time.
- 2** Sus piezas especiales permiten un remate perfecto en escaleras, muretes, spas y otras construcciones en el interior de la piscina.
Special pieces allow a perfect finish in stairs, inner walls, spas, and other structures inside the pool.
- 3** Perfecta adhesión. No saltan las juntas ni las piezas.
Perfect adhesion. Joints and tiles become perfectly fixed.
- 4** Más higiénico y seguro.
More hygienic and safe.

PIEZAS ESPECIALES · SPECIAL PIECES
Disponible en todos los colores · Available in all colors

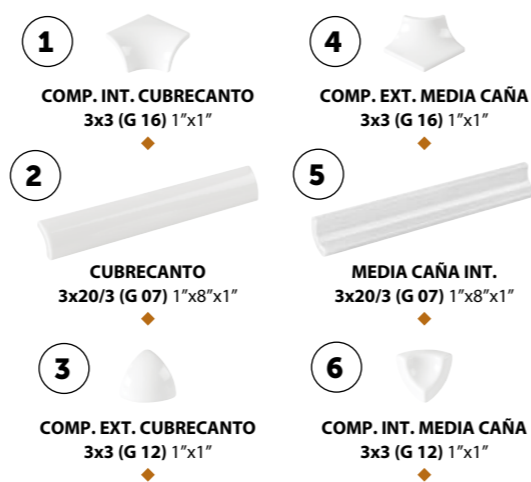

POOL PORC. LUZ
10 x 10 (G 62) 4" x 4"

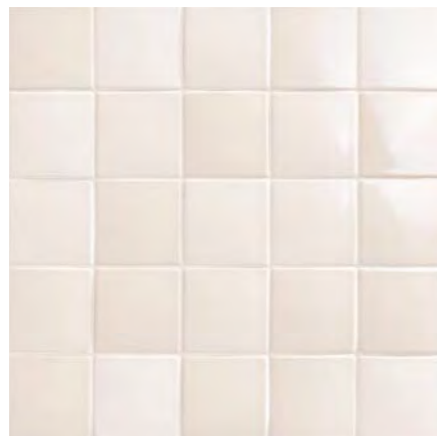

POOL PORC. CLOUD
10 x 10 (G 62) 4" x 4"

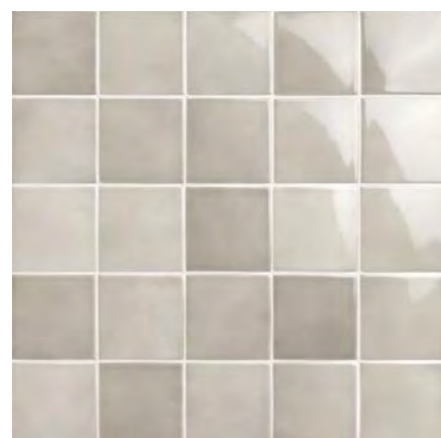

POOL PORC. IRON
10 x 10 (G 62) 4" x 4"

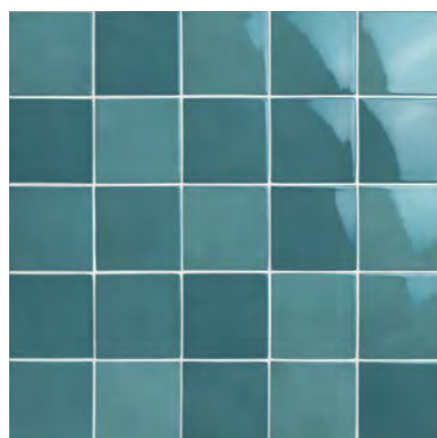

POOL PORC. EMERALD
10 x 10 (G 62) 4" x 4"

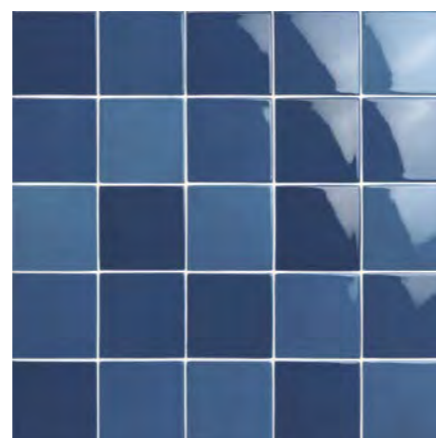

POOL PORC. INDIGO
10 x 10 (G 62) 4" x 4"



PACKING PIEZAS ESPECIALES

FORMATO	PULGADAS	PZ/CAJA	ML	CAJA/PLT	PESO/CAJA	PESO/PLT
3 x 3 COMP. INT. MEDIA CAÑA	1" x 1"	100	3	196	0,85	182
3 x 20/3 MEDIA CAÑA INT.	1" x 8" x 1"	36	7,2	196	1,98	405
3 x 3 COMP. EXT. MEDIA CAÑA	1" x 1"	100	3	196	1,6	310
3 x 3 COMP. INT. CUBRECANTO	1" x 1"	100	3	196	1,6	310
3 x 20/3 CUBRECANTO	1" x 8" x 1"	36	7,2	196	1,98	405
3 x 3 COMP. EXT. CUBRECANTO	1" x 1"	100	3	196	0,85	182

PACKING BASES

FORMATO	PULGADAS	PZ/CAJA	M²	CAJA/PLT	PESO/CAJA	PESO/PLT
10 x 10 REVESTIMIENTO	4" x 4"	50	0,5	120	10,5	1.275

¿DE QUÉ COLOR SERÁ EL AGUA DE MI PISCINA?

WHICH WILL BE THE COLOUR OF THE WATER OF MY POOL?

El revestimiento que utilicemos para nuestra piscina influirá en la tonalidad del agua. Cada color, textura o acabado afecta de forma diferente creando matices únicos.

The tiles we will use in our pool will affect the tonality of the water. Every colour, texture or finish produce differences, creating unique shades.

El agua tiende a ser de color azul

Water tends to be blue

El motivo es que el agua no absorbe las ondas cortas de luz (azules y violetas), y éstas rebotan y son captadas por nuestros ojos. A más profundidad más azul y a menos profundidad más transparente. **La elección del revestimiento de nuestra piscina nos ayudará a potenciar o matizar estos bellos tonos azules.**

Water does not absorb the light short waves (blue and violet), so these waves are sent back and captured in our eyes. The more deep, the more blue. Less volume, water becomes more transparent. **Choosing the right color of tile for our pool , will help us strengthening these beautiful blue tonalities.**

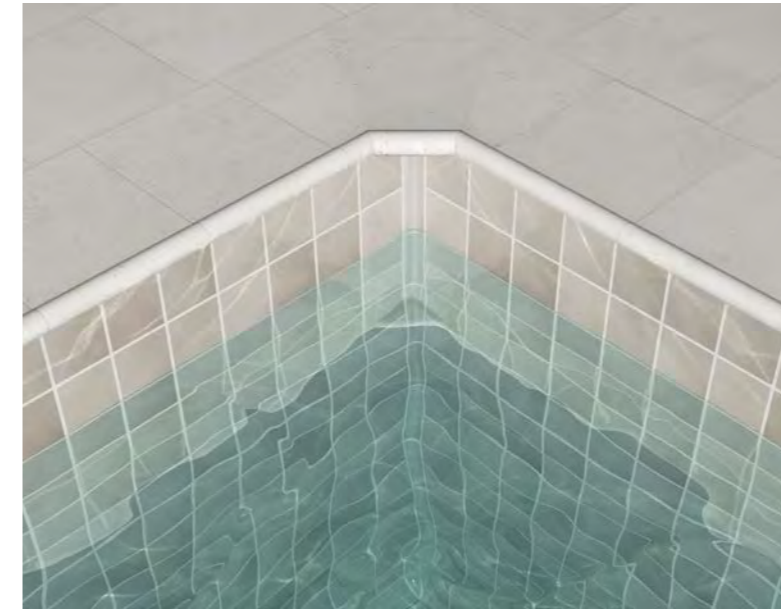

Simulación tonalidad del agua según color de revestimiento utilizado.
Water colour simulation depending on the colour of the tiles used.

POOL PORC. IRON 10x10 MOODBOARD INSPIRATION

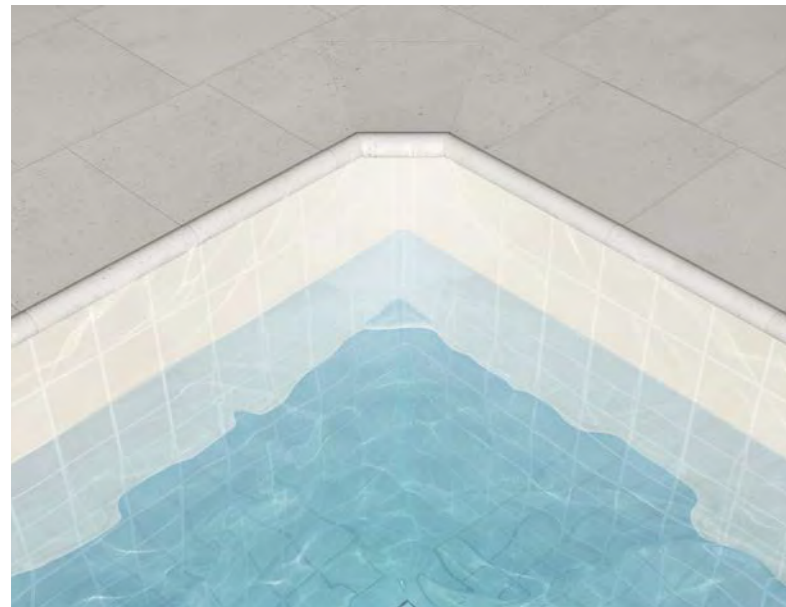
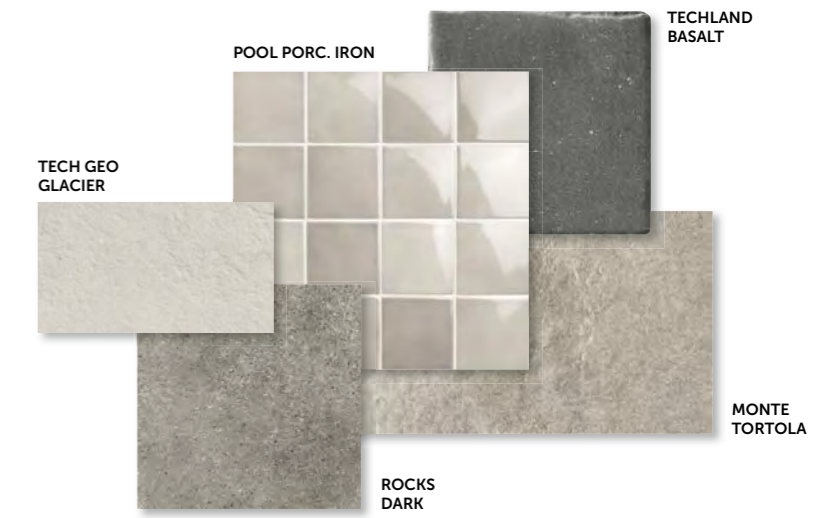

Simulación tonalidad del agua según color de revestimiento utilizado.
Water colour simulation depending on the colour of the tiles used.

POOL PORC. LUZ 10x10 MOODBOARD INSPIRATION

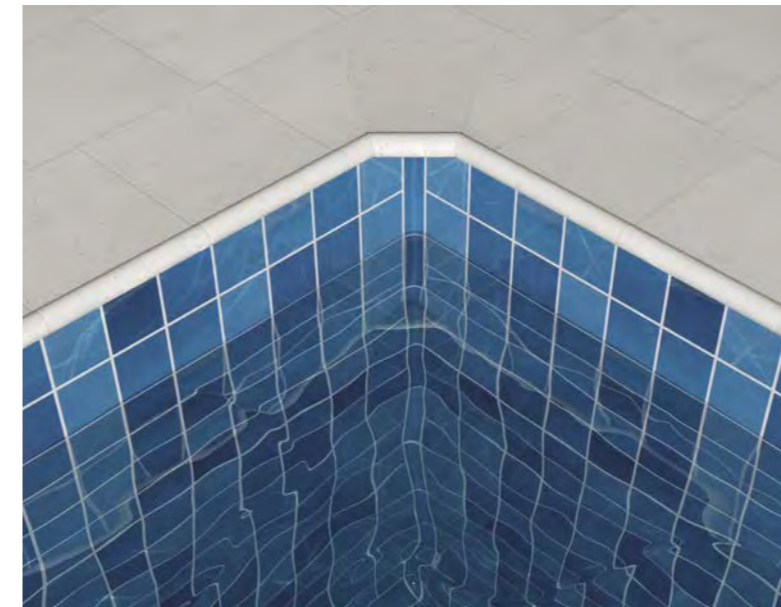

Simulación tonalidad del agua según color de revestimiento utilizado.
Water colour simulation depending on the colour of the tiles used.

POOL PORC. INDIGO 10x10 MOODBOARD INSPIRATION

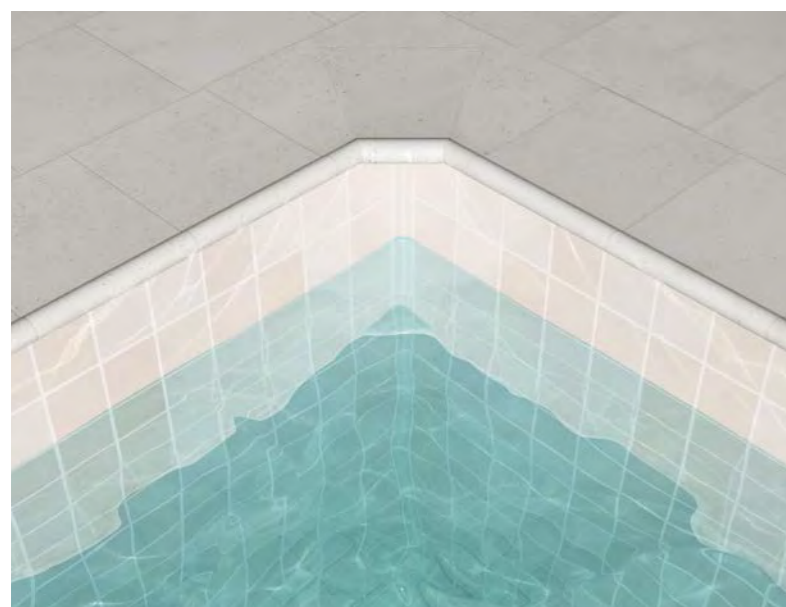
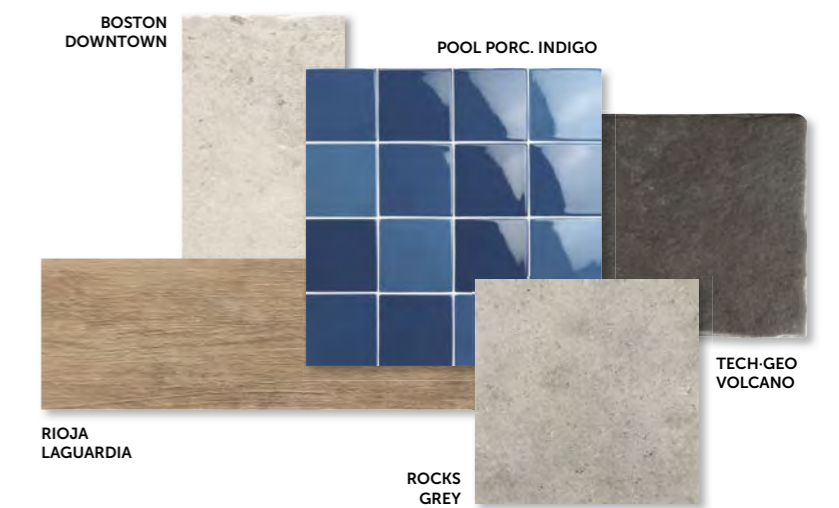

Simulación tonalidad del agua según color de revestimiento utilizado.
Water colour simulation depending on the colour of the tiles used.

POOL PORC. CLOUD 10x10 MOODBOARD INSPIRATION

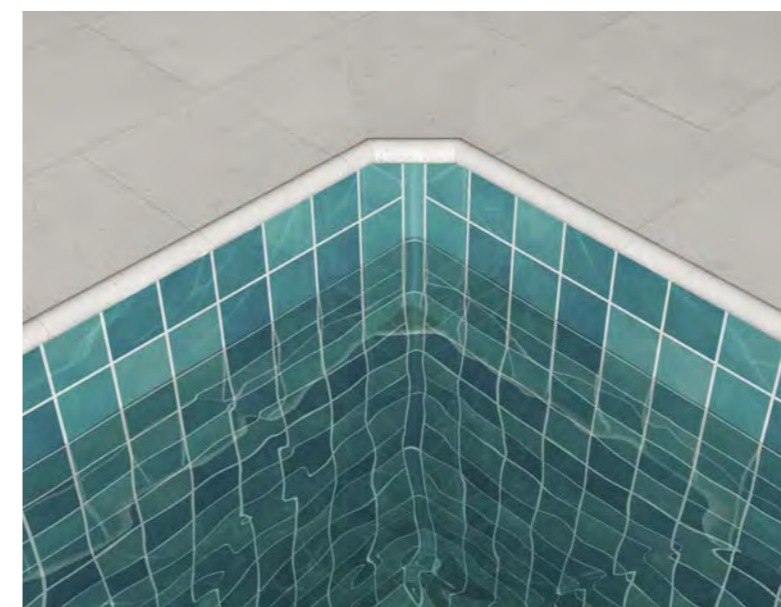
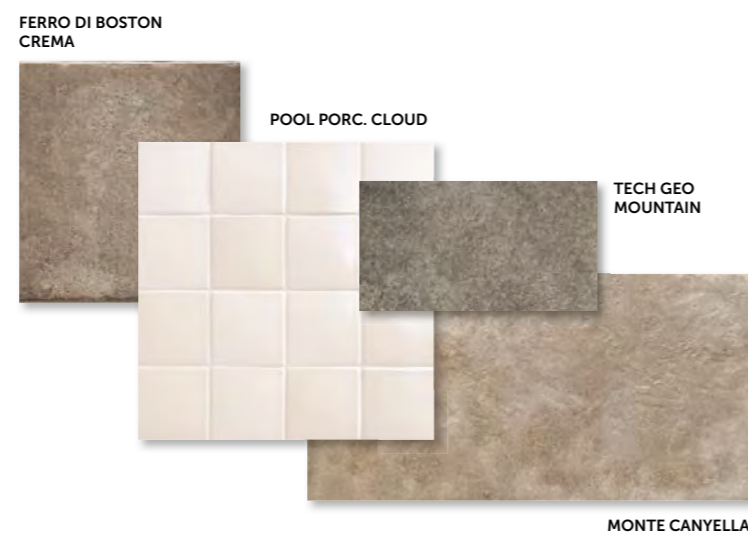

Simulación tonalidad del agua según color de revestimiento utilizado.
Water colour simulation depending on the colour of the tiles used.

POOL PORC. EMERALD 10x10 MOODBOARD INSPIRATION

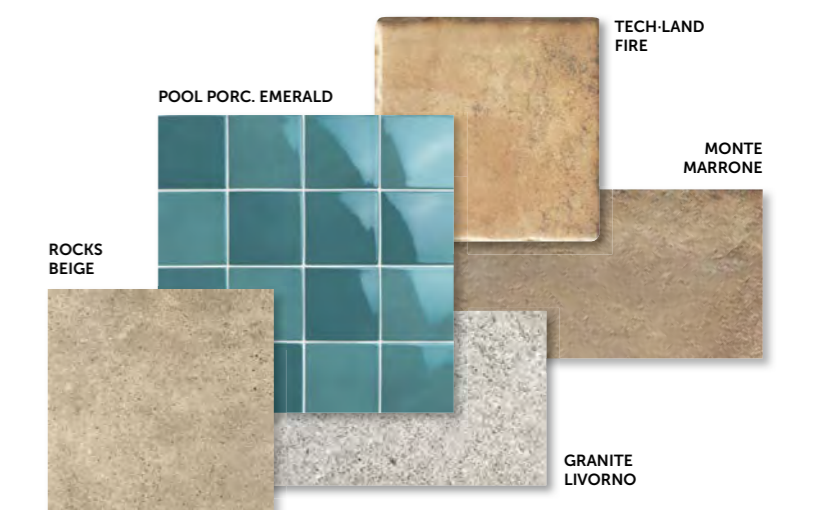

REVESTIMIENTOS QUE COORDINAN
CON NUESTRAS SERIES DE TERRAZA
REVESTMENTS COMBINING WITH OUR SERIES FOR TERRACES

Cualquiera de nuestras series de terraza es apta para revestir el interior de la piscina, ya que cumplen con todas las exigencias requeridas. De esta manera se consigue una continuidad estética completa. Una integración total de la piscina en el entorno que la rodea. Mismo estilo, mismo color, mismo acabado.

Any of our collections for terrace is suitable to tile the interior of our pool, since these series accomplish with every demanded requirement. In this way we get an aesthetic continuous atmosphere. A full integration of the pool with the environment around. Same colours, same style, same finish.

TERRACE + POOL INTERIOR
IN&OUT SOLUTIONS



Pavimento Rioja Logroño 21x60 · 8" x 23,6"
Borde Piscina Logroño 30x36/4 · 11,8" x 14"
Esq. Int. Borde Piscina Logroño 51,2x51,2 · 20,1" x 20,1"
Peldaño Angular Logroño 32x32/4 · 13" x 13"

Revestimiento piscina: Rioja Logroño 21x60 · 8" x 23,6"

SOLUCIONES
PARA EL VASO DE PISCINA
SOLUTIONS FOR THE INTERIOR OF THE POOL

Naturcer cuenta con toda una serie de piezas especiales que solucionarán cualquier problema constructivo: Escaleras de acceso a la piscina, bancos, muretes, camas de agua, zonas de spa, etc. Remates perfectos y acabados totalmente personalizados.

Naturcer offers a wide range of special pieces, giving solutions to any constructive issue. Stairs to enter into the pool, benches, walls, water beds, spa areas, ...etc. Perfect and customized finish.



- | | | |
|---|--|--|
| 2

COMP. INT. MEDIA CAÑA
4x4 (G 17) 1,5"x1,5" | 1

MEDIA CAÑA INT.
4x30/4 (G 12) 1,5"x11,8"x1,5"
4x22,5/4 (G 12) 1,5"x8,8"x1,5" |
COMP. EXT. CUBRECANTO
4x4 (G 17) 1,5"x1,5" |
| 3

COMP. EXT. MEDIA CAÑA
4x4 (G 17) 1,5"x1,5" | 4

CUBRECANTO
4x30/4 (G 13) 1,5"x11,8"x1,5"
4x22,5/4 (G 13) 1,5"x8,8"x1,5" |
COMP. INT. CUBRECANTO
4x4 (G 17) 1,5"x1,5" |

COLORES DISPONIBLES · AVAILABLE COLOURS

TECH-LAND			
	FIRE	NATURE	BASALT
D'Anticatto			
	BIANCO	AZURRO	
ROCKS			
	WHITE	GREY	DARK
	BEIGE	BROWN	
GRANITE			
	CARRARA	LIVORNO	GROSSETO
	CALABRIA	EMPOLI	
	HARO	LOGROÑO	BRIONES
	LAGUARDIA	ABALOS	



Pavimento D'Anticatto Bianco 22,5x45 · 8,8"x17,7"
Peldaño Angular D'Anticatto Bianco 120x32x2,5 · 47"x12,5"x1"
Áng. Pel. Angular Int. D'Anticatto Bianco 120x32x45/2,5 · 47"x12,6"x17,7"

Revestimiento Piscina:
D'Anticatto Bianco 11x22,5 · 4,3"x8,8"
Media Caña Int. D'Anticatto Bianco 4x30x4 · 1,5"x11,8"x1,5"
Complemento Int. Media Caña D'Anticatto Bianco 4x4 · 1,5"x1,5"



Pavimento D'Anticatto Azurro 22,5x45 · 8,8"x17,7"
Pavimento D'Anticatto Azurro 22,5x22,5 · 8,8"x8,8"
Pavimento D'Anticatto Azurro 11x22,5 · 4,3"x8,8"
Peldaño Angular D'Anticatto Azurro 120x32x2,5 · 47"x12,5"x1"
Áng. Pel. Angular Int. D'Anticatto Azurro 120x32x45/2,5 · 47"x12,6"x17,7"

Revestimiento Piscina:
D'Anticatto Azurro 11x22,5 · 4,3"x8,8"
Media Caña Int. D'Anticatto Azurro 4x30x4 · 1,5"x11,8"x1,5"
Complemento Int. Media Caña D'Anticatto Azurro 4x4 · 1,5"x1,5"



Pavimento Boston Downtown 22,5x45 · 8,8"x17,7"
Vierteaguas Boston Downtown 15x22,5/4 · 5,9"x8,8"

Revestimiento Piscina:
Boston Downtown 22,5x45 · 8,8"x17,7"



Pavimento Tech Geo Volcano 22,5x33 · 8,8"x13"
Pavimento Tech Geo Volcano 22,5x22,5 · 8,8"x8,8"
Pavimento Tech Geo Volcano 11x22,5 · 4,3"x8,8"
Peldaño Curvo Tech Geo Volcano 22,5x33/4 · 8,8"x13"

Revestimiento Piscina:
Tech Geo Volcano 11x22,5 · 4,3"x8,8"