

Materia

6 COLOURS

6 SIZES

3 SURFACES

Materia is conceived to introduce a new expression of ceramics. A noble material with a great history relaunches its creative potential thanks to the graphic technique and the diverse esthetics of materials like metal, stone and ceramics itself.

Materia nasce dall'idea sviluppata in Piemme per una nuova espressione della ceramica, una materia nobile con una grande storia creativa che ritrova e rilancia il proprio estro originario e, grazie alla sua tecnica grafica, analizza l'estetica di materie differenti, come il metallo, la pietra e la ceramica stessa,

Mit „Materia“ möchte Piemme der Keramik einen neuen Ausdruck verleihen. Das edle und geschichtsträchtige Material findet zurück zu seinen Wurzeln, erfindet sich neu und analysiert mit seiner graphischen Technik seine eigene Ästhetik sowie die anderer Materialien wie Metall und Stein.

« Materia » est l'aboutissement d'une idée développée par Piemme: donner à la céramique, matière noble, riche d'une histoire nourrie de créativité, une nouvelle forme d'expression où elle puisse retrouver son style originel. Ses techniques graphiques lui permettent d'analyser les dimensions esthétiques de matières comme le métal, la pierre ainsi que la céramique.

Materia



Spazi Residenziali
Residential Spaces

P. 5

Spazi Pubblici
Public Areas

P. 21

Informazioni Tecniche
Technical Information

P. 45

La forza espressiva della ceramica secondo Piemme, riesce a dare nuova eleganza ed appeal ad una materia di per sé fredda come il metallo, proprio grazie alla possibilità di fondervi e compenetrarvi altri aspetti di una materia affascinante come la pietra, arricchendo con grande profondità le nuances più flat del metallo stesso.

The expressive force of Piemme ceramics bestows new elegance and appeal on metal, an intrinsically cold material, through this ability to merge and mingle it with other aspects native to stone with all its natural beauty, thus enhancing the flatter shades of metal with great depth.

Mit ihrer Ausdruckskraft schafft es die Keramik von Piemme, einem an sich kalten Material wie Metall eine neue Eleganz und Ausstrahlung zu verleihen. Die Keramik verschmilzt mit dem Metall und bringt die Eigenschaften eines weiteren faszinierenden Materials mit ein: des Steins. So erhält das eher flach wirkende Metall mehr Tiefe.

Cette force expressive de la céramique revue par Piemme réussit à insuffler une nouvelle élégance et un nouvel attrait à une matière comme le métal, intrinsèquement froide. Elle y parvient parce qu'elle peut y incorporer d'autres aspects de ce matériau fascinant qu'est la pierre, enrichissant ainsi de ses nuances profondes celles, plus plates, du métal.

Spazi Residenziali

Residential Spaces
Wohnanlagen
Espaces Résidentiels



COLORI / COLOURS

AMBIENTI / AMBIENT

PAGINA / PAGE

Deep / Shimmer

Living

6

Deep

Living

8

Reflex

Living

10

Opal / Nacre

Bathroom

13

Shimmer / Rust

Bathroom

17

Materia
Residential Spaces

5







Ceramics is restored to its status as a fine material, now with new vitality and a striking personality. The "Materia" collection, with its expressive peculiarities and 3D structures, is superior to any other ceramic surface.

Das edle keramische Material findet einen neuen Lebens und eine besondere Persönlichkeit. Die Serie „Materia“ unterscheidet sich mit ihren ästhetischen Merkmalen und ihren 3D-Strukturen von jeder anderen Oberfläche aus Keramik.

La noble matière céramique retrouve dès lors sa sève vitale et sa personnalité marquée. Ses particularités expressives et ses structures 3D permettent à la série « Materia » de se distinguer des autres surfaces céramiques.

La nobile materia ceramica ritrova una nuova linfa vitale e una spiccata personalità. La serie "Materia" con le sue peculiarità espressive e le strutture 3d emerge rispetto qualunque altra superficie ceramica.





Shimmer / Rust

Starting from the tactile effects inspired by the various glossy or oxidised metals and the natural look of stone, in "Materia" our designers have created a new material.

Ausgehend von der Wirkung unterschiedlicher, glänzender oder oxidiertes Metalle und von der natürlichen Optik des Steins haben unsere Designer „Materia“ wie einen neuen Stoff geschaffen.

60×119,5 - 24"×47½" Naturale Rettificato

S'appuyant sur les effets de matières, brillants ou oxydés, suggérés par les différents métaux, ainsi que sur l'aspect naturel de la pierre, nos designers ont créé une nouvelle matière : « Materia ».

Partendo dagli effetti materici suggeriti dai differenti metalli, lucenti o ossidati e dall'aspetto naturale della pietra, i nostri designer hanno creato una nuova "Materia".

119,5×119,5 - 47½"×47½" Naturale Rettificato

60×60 - 24"×24" Jade Naturale Rettificato



Materia
Residential Spaces



Spazi Pubblici

Public Areas
Öffentliche Räumlichkeiten
Espaces Publics



COLORI / COLOURS

AMBIENTI / AMBIENT

PAGINA / PAGE

Deep / Rust / Opal

Restaurant

23

Opal / Deep

Museum Lobby

24

Reflex / Nacre

Food Court

29

Reflex

Bathroom

33

Rust / Shimmer

Museum Restaurant

36

Reflex

Museum Cafè

40

Deep / Rust / Opal

An unusual effect, creating surfaces that merge metal, Corten steel, stone and ceramic in a refined, contemporary look.

Eine ganz neue Wirkung für Oberflächen, die Metall, Cortenstahl, Stein und Keramik in einer raffiniertmodernen Ästhetik verbinden.

Un effet inédit sur des surfaces où métal, corten, pierre et céramique se conjuguent pour créer une esthétique raffinée et contemporaine.

Un effetto inedito per superfici che coniugano metallo, corten, pietra e ceramica, in un'estetica raffinata e contemporanea.

30×60 - 12"×24" Garage Naturale Rettificato / 60×119,5 - 24"×47½" Naturale Rettificato / 119,5×119,5 - 47½"×47½" Naturale Rettificato







Nacre

Thanks to sophisticated production technologies, "Materia" combines the ground look typical of handpolished metal with the small flaws that denote genuine craftsmanship.

Dank ausgeklügelter Produktionstechniken vereint „Materia“ die typische Glätte von handgeschliffenem Metall mit den kleinen Schönheitsfehlern von Handwerksprodukten.

Grâce à des technologies de production de pointe, « Materia » associe l'effet de rodage typique du métal poli à la main aux petites imperfections propres au travail artisanal.

Grazie a sofisticate tecnologie produttive "Materia" abbina l'effetto di smerigliatura tipico del metallo levigato a mano, alle piccole imperfezioni della lavorazione artigianale.

60x119,5 - 24"x47½" Lappato Rettificato



Materia
Public Areas



Reflex

The unusual aesthetic synthesis generated by this blending of materials has given us a collection rich in contemporary combinations.

Aus der neuartigen ästhetischen Synthese von Stoffen entsteht eine facettenreiche und moderne Kollektion.

La synthèse esthétique née de la fusion des matières a engendré une collection riche de combinaisons contemporaines.

La sintesi estetica inedita nata dalla fusione tra materie, ha generato una collezione ricca di combinazioni contemporanee.

30x60 - 12"x24" Lappato Rettificato / 30x119,5 - 12"x47½" Raku Warm Naturale Rettificato / 60x60 - 24"x24" Naturale Rettificato



Materia
Public Areas









Reflex

The perfect solution for coordinating an interior and outdoor mood with a floor that maintains the same design as the interior version, providing strength, style and durability.

Die perfekte Lösung für eine koordinierte Oberfläche innen wie außen, mit einem Bodenbelag, der mit dem gleichen Design der Version für Innenräume Beständigkeit und Langlebigkeit an bietet.

La solution parfaite pour coordonner intérieur et extérieur par un revêtement de sol qui offre style, résistance et solidité.

La soluzione perfetta
per coordinare il mood interno
ed esterno con un pavimento
che offre resistenza, stile e durabilità.

90×90 - 36"×36" Grip Rettificato 20MM

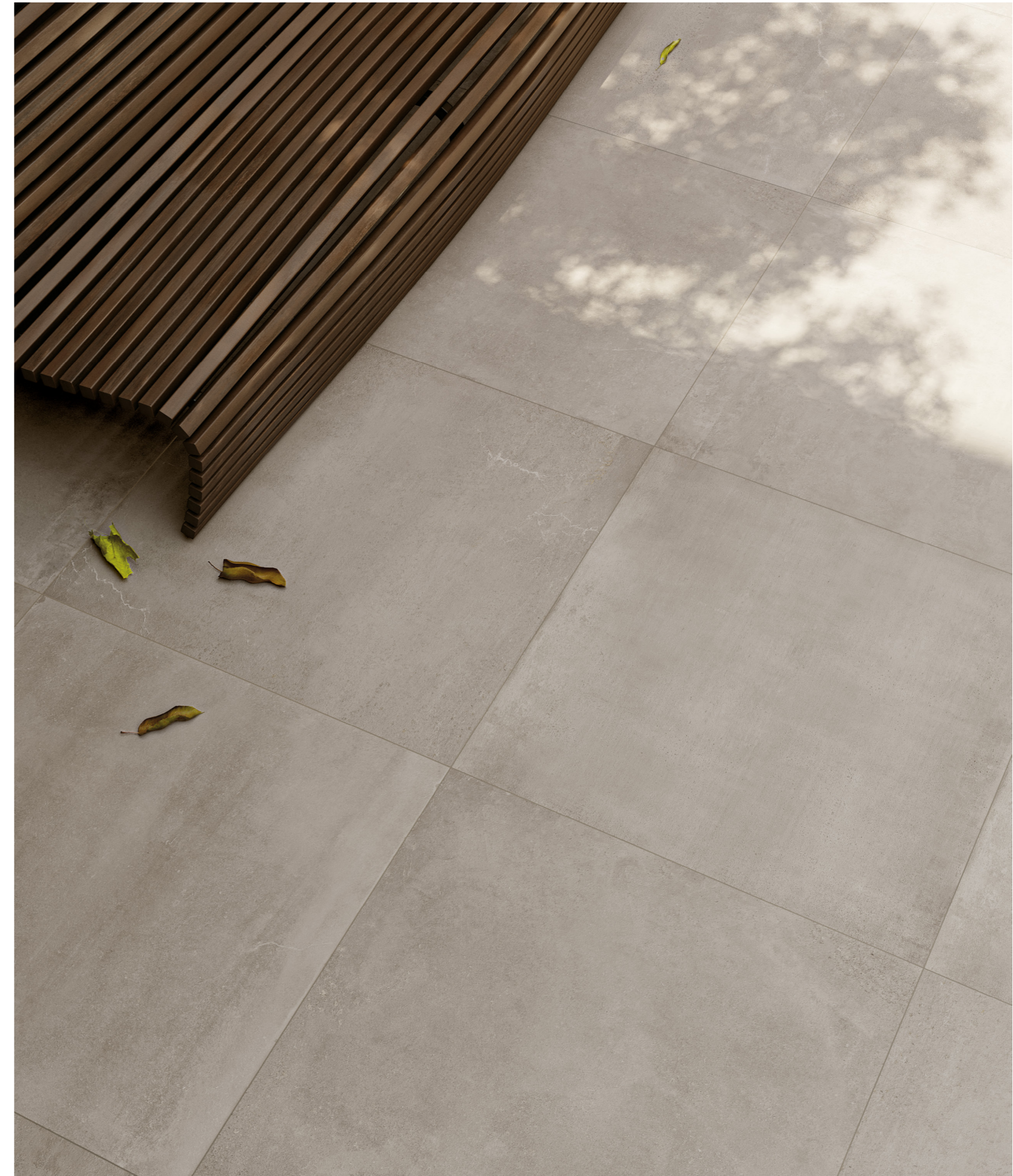

Materia
Public Areas

Informazioni Tecniche

6

Colori
Colours
Farben
Couleurs

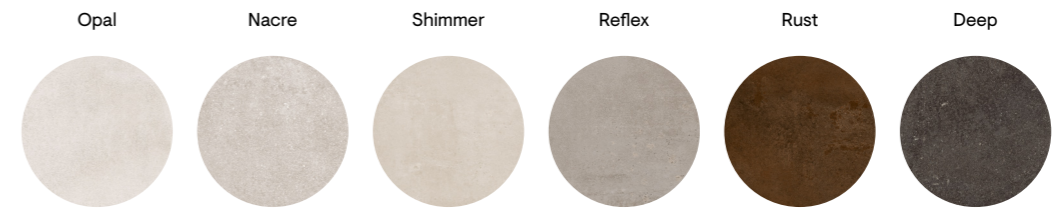

6

Formati
Sizes
Formate
Formats

119,5×119,5 *60×119,5 90×90 *89,5×89,5 60×60 30×60
47½"×47½" 24"×47½" 36"×36" 35¼"×35¼" 24"×24" 12"×24"



*formato modulare con 60x60 e 30x60 / modular size, can be matched with 60x60 and 30x60 size /
modulares, sprich mit dem Format 60x60 und 30x60 kombinierbares Format / format modulaire pouvant être coordonné au format 60x60 et 30x60

3

Spessori
Thickness
Stärke
Epaisseur

9 9,5 20

3

Superfici
Surfaces
Oberflächen
Surfaces

Naturale Lappato Grip

2

Strutture 3D
3D structures
Strukturen
Décorations en relief

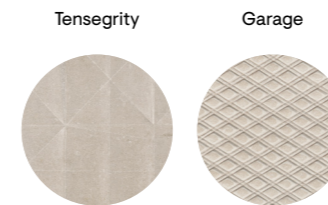

i

Effetto Pietra - Metallo
Stone Look - Metal
Natursteinoptik - Metall
Effet Pierre - Métal

Rivestimento
Wall Tiles
Wandfliesen
Revêtement

Pavimento
Floor Tiles
Bodenfliesen
Sol

Gres fine porcellanato ad impasto colorato
Coloured-body fine porcelain stoneware
Feinsteinzeug aus farbiger Masse
Grès cérame fin à pâte colorée

Tecnologia digitale
Digital technology
Digital technologie
Technologie numérique



Opal



119,5x119,5 - 47 1/4"x47 1/4"
03071 | Materia Opal Nat/Ret
03075 | Materia Opal Lap/Ret



*89,5x89,5 - 35 1/4"x35 1/4"
03468 | Materia Opal Nat/Ret
03473 | Materia Opal Lap/Ret



60x60 - 24"x24"
02847 | Materia Opal Nat/Ret
02853 | Materia Opal Lap/Ret

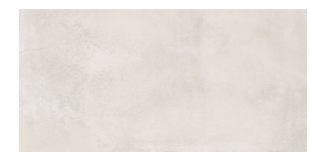

30x60 - 12"x24"
02827 | Materia Opal Nat/Ret
02834 | Materia Opal Lap/Ret



*60x119,5 - 24"x47 1/4"
02859 | Materia Opal Nat/Ret
02866 | Materia Opal Lap/Ret



60x60 - 24"x24"
02981 | Materia Platinum Nat/Ret
(mix 4 graphics)



30x60 - 12"x24"
02936 | Materia Garage Opal Nat/Ret



30x60 - 12"x24"
03079 | Materia Tensegrity Opal Nat/Ret



*30x119,5 - 12"x47 1/4"
02944 | Materia Raku Warm Nat/Ret
(handcrafted decor)

* formato modulare con 60x60 e 30x60 / modular size, can be matched with 60x60 and 30x60 size /
modulares, sprich mit dem Format 60x60 und 30x60 kombinierbares Format / format modulaire pouvant être coordonné au format 60x60 et 30x60

Pezzi speciali / Special pieces  Battiscopa 4,5x60 € 9,5  Gradino Costa Retta 30x119,5 € 9,5  Bacchetta Jolly 1,5x119,5 € 9,5  Unghia Jolly 1,5x1,5 € 9,5



Nacre



± 9,5

*60x119,5 - 24"x47 1/2"

02861 | Materia Nacre Nat/Ret
02867 | Materia Nacre Lap/Ret



± 9,5

60x60 - 24"x24"

02848 | Materia Nacre Nat/Ret
02854 | Materia Nacre Lap/Ret



60x60 - 24"x24"

02980 | Materia Gold Nat/Ret
(mix 4 graphics)



*30x119,5 - 12"x47 1/2"

02944 | Materia Raku Warm Nat/Ret
(handcrafted decor)



± 9,5

30x60 - 12"x24"

02828 | Materia Nacre Nat/Ret
02836 | Materia Nacre Lap/Ret



30x60 - 12"x24"

02937 | Materia Garage Nacre Nat/Ret



30x60 - 12"x24"

03081 | Materia Tensegrity Nacre Nat/Ret

* formato modulare con 60x60 e 30x60 / modular size, can be matched with 60x60 and 30x60 size /
modulares, sprich mit dem Format 60x60 und 30x60 kombinierbares Format / format modulaire pouvant être coordonné au format 60x60 et 30x60

Pezzi speciali
Special pieces



Battiscopa 4,5x60 ± 9,5

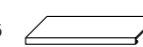

Gradino Costa Retta 30x119,5 ± 9,5

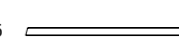

Bacchetta Jolly 1,5x119,5 ± 9,5

↳ Unghia Jolly 1,5x1,5 ± 9,5



Shimmer



± 9

119,5x119,5 - 47½"x47½"

03072 | Materia Shimmer Nat/Ret
03076 | Materia Shimmer Lap/Ret



± 20

90x90 - 36"x36"

02982 | Materia Shimmer Grip/Ret



± 9,5

60x60 - 24"x24"

02849 | Materia Shimmer Nat/Ret
02855 | Materia Shimmer Lap/Ret



± 9,5

30x60 - 12"x24"

02829 | Materia Shimmer Nat/Ret
02838 | Materia Shimmer Lap/Ret



± 9,5

*60x119,5 - 24"x47½"

02862 | Materia Shimmer Nat/Ret
02868 | Materia Shimmer Lap/Ret



± 9,5

*89,5x89,5 - 35¼"x35¼"

03469 | Materia Shimmer Nat/Ret
03474 | Materia Shimmer Lap/Ret



30x60 - 12"x24"

02938 | Materia Garage Shimmer Nat/Ret



*30x119,5 - 12"x47½"

02944 | Materia Raku Warm Nat/Ret
(handcrafted decor)



30x60 - 12"x24"

03082 | Materia Tensegrity Shimmer Nat/Ret



20x15 - 8"x6"

02989 | Soul Kaleido Light Nat/Ret

* formato modulare con 60x60 e 30x60 / modular size, can be matched with 60x60 and 30x60 size /
modulares, sprich mit dem Format 60x60 und 30x60 kombinierbares Format / format modulaire pouvant être coordonné au format 60x60 et 30x60

Pezzi speciali
Special pieces



Battiscopa 4,5x60 ± 9,5

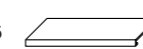

Gradino Costa Retta 30x119,5 ± 9,5

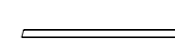

Bacchetta Jolly 1,5x119,5 ± 9,5

Unghia Jolly 1,5x1,5 ± 9,5



Elemento L 30x90 ± 20

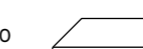

Gradone 30x90 ± 20



Griglia Scolo 18x90 ± 20



Gres fine porcellanato ad impasto colorato
Tecnologia Digitale

Coloured-body fine porcelain stoneware
Digital Technology

Feinsteinzeug aus farbiger Masse
Digital Technologie

Grès cérame fin à pâte colorée
Technologie Numérique

Reflex



± 9,5

*60×119,5 - 24"×47½"

02863 | Materia Reflex Nat/Ret
02869 | Materia Reflex Lap/Ret



*30×119,5 - 12"×47½"

02944 | Materia Raku Warm Nat/Ret
(handcrafted decor)



± 20

90×90 - 36"×36"

02983 | Materia Reflex Grip/Ret



± 9,5

60×60 - 24"×24"

02850 | Materia Reflex Nat/Ret
02856 | Materia Reflex Lap/Ret



± 9,5

30×60 - 12"×24"

02831 | Materia Reflex Nat/Ret
02841 | Materia Reflex Lap/Ret

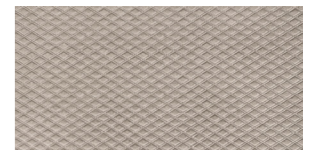

30×60 - 12"×24"

02939 | Materia Garage Reflex Nat/Ret

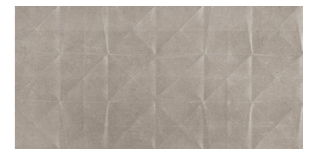

30×60 - 12"×24"

03083 | Materia Tensegrity Reflex Nat/Ret

* formato modulare con 60x60 e 30x60 / modular size, can be matched with 60x60 and 30x60 size /
modulares, sprich mit dem Format 60x60 und 30x60 kombinierbares Format / format modulaire pouvant être coordonné au format 60x60 et 30x60

Pezzi speciali
Special pieces

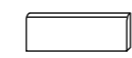

Battiscopa 4,5×60 ± 9,5

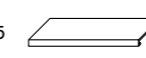

Gradino Costa Retta 30×119,5 ± 9,5

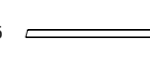

Bacchetta Jolly 1,5×119,5 ± 9,5

Unghia Jolly 1,5×1,5 ± 9,5

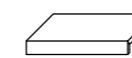

Elemento L 30×90 ± 20

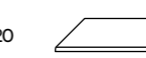

Gradone 30×90 ± 20

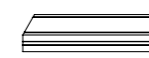

Griglia Scolo 18×90 ± 20



Rust



119,5x119,5 - 47 1/2"x47 1/2"
03073 | Materia Rust Nat/Ret
03077 | Materia Rust Lap/Ret



*60x119,5 - 24"x47 1/2"
02864 | Materia Rust Nat/Ret
02871 | Materia Rust Lap/Ret



*30x119,5 - 12"x47 1/2"
02944 | Materia Raku Warm Nat/Ret
(handcrafted decor)



*89,5x89,5 - 35 1/2"x35 1/2"
03471 | Materia Rust Nat/Ret
03475 | Materia Rust Lap/Ret



60x60 - 24"x24"
02945 | Materia Jade Nat/Ret
(mix 4 graphics)



60x60 - 24"x24"
02851 | Materia Rust Nat/Ret
02857 | Materia Rust Lap/Ret



30x60 - 12"x24"
02832 | Materia Rust Nat/Ret
02843 | Materia Rust Lap/Ret

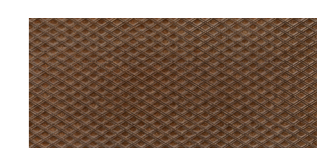

30x60 - 12"x24"
02941 | Materia Garage Rust Nat/Ret

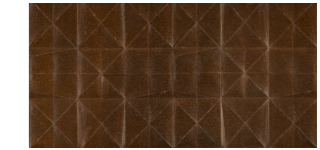

30x60 - 12"x24"
03084 | Materia Tensegrity Rust Nat/Ret



20x15 - 8"x6"
02990 | Soul Kaleido Dark Nat/Ret

* formato modulare con 60x60 e 30x60 / modular size, can be matched with 60x60 and 30x60 size /
modulares, sprich mit dem Format 60x60 und 30x60 kombinierbares Format / format modulaire pouvant être coordonné au format 60x60 et 30x60

Pezzi speciali Special pieces  Battiscopa 4,5x60 \pm 9,5  Gradino Costa Retta 30x119,5 \pm 9,5  Bacchetta Jolly 1,5x119,5 \pm 9,5  Unghia Jolly 1,5x1,5 \pm 9,5



Deep



± 9

119,5x119,5 - 47½"x47½"

03074 | Materia Deep Nat/Ret
03078 | Materia Deep Lap/Ret



± 20

90x90 - 36"x36"

02984 | Materia Deep Grip/Ret



± 9,5

60x60 - 24"x24"

02852 | Materia Deep Nat/Ret
02858 | Materia Deep Lap/Ret

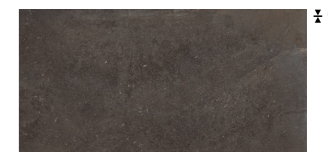

± 9,5

30x60 - 12"x24"

02833 | Materia Deep Nat/Ret
02846 | Materia Deep Lap/Ret

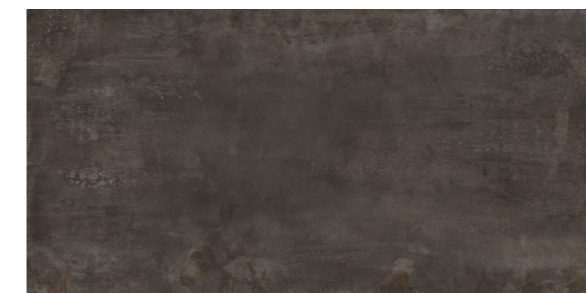

± 9,5

*60x119,5 - 24"x47½"

02865 | Materia Deep Nat/Ret
02872 | Materia Deep Lap/Ret



± 9,5

*89,5x89,5 - 35¼"x35¼"

03472 | Materia Deep Nat/Ret
03476 | Materia Deep Lap/Ret

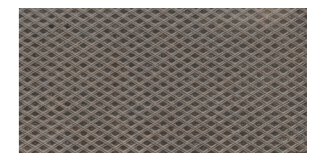

30x60 - 12"x24"

02942 | Materia Garage Deep Nat/Ret

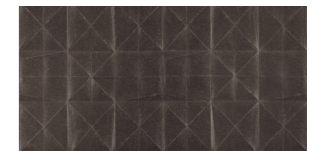

30x60 - 12"x24"

03085 | Materia Tensegrity Deep Nat/Ret

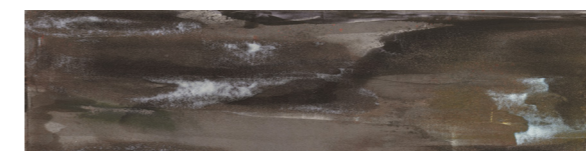

*30x119,5 - 12"x47½"

02943 | Materia Raku Cold Nat/Ret
(handcrafted decor)



60x60 - 24"x24"

02946 | Materia Zaphire Nat/Ret
(mix 4 graphics)

* formato modulare con 60x60 e 30x60 / modular size, can be matched with 60x60 and 30x60 size /
modulares, sprich mit dem Format 60x60 und 30x60 kombinierbares Format / format modulaire pouvant être coordonné au format 60x60 et 30x60

Pezzi speciali
Special pieces



Battiscopa 4,5x60 ± 9,5

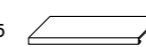

Gradino Costa Retta 30x119,5 ± 9,5

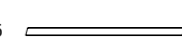

Bacchetta Jolly 1,5x119,5 ± 9,5

Unghia Jolly 1,5x1,5 ± 9,5



Elemento L 30x90 ± 20

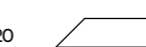











Gradone 30x90 ± 20

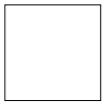
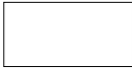

Griglia Scolo 18x90 ± 20













Riepilogo Gamma

Collection
Serie
Gamme

	Formati Sizes											
		119,5x119,5 - 47 1/2 x 47 1/2"	90x90 - 36"x36"	89,5x89,5 - 35 1/4"x35 1/4"	60x119,5 - 24"x47 1/2"	60x60 - 24"x24"	30x60 - 12"x24"	Din 51130	Din 51097	Dcof		
		± 9	± 20	± 9,5	± 9,5	± 9,5	± 9,5					
 Opal	Nat/Ret	03071		03468	02859	02847	02827	V2	R10	A+B	>0.42	
	Lap/Ret	03075		03473	02866	02853	02834					
 Nacre	Nat/Ret				02861	02848	02828	V2	R10	A+B	>0.42	
	Lap/Ret				02867	02854	02836					
 Shimmer	Nat/Ret	03072		03469	02862	02849	02829	V2	R10	A+B	>0.42	
	Lap/Ret	03076		03474	02868	02855	02838					
	Grip/Ret		02982						R11	A+B+C	>0.42	
 Reflex	Nat/Ret				02863	02850	02831	V2	R10	A+B	>0.42	
	Lap/Ret				02869	02856	02841					
	Grip/Ret		02983						R11	A+B+C	>0.42	
 Rust	Nat/Ret	03073		03471	02864	02851	02832	V2	R10	A+B	>0.42	
	Lap/Ret	03077		03475	02871	02857	02843					
 Deep	Nat/Ret	03074		03472	02865	02852	02833	V2	R10	A+B	>0.42	
	Lap/Ret	03078		03476	02872	02858	02846					
	Grip/Ret		02984						R11	A+B+C	>0.42	





Riepilogo Gamma

Collection
Serie
Gamme

	Formati Sizes	Strutture 3D 3D Structures							
		Tensegrity 30x60 - 12"x24"	Garage 30x60 - 12"x24"	Platinum 60x60 - 24"x24"	Gold 60x60 - 24"x24"	Jade 60x60 - 24"x24"	Zaphire 60x60 - 24"x24"	Raku 30x119,5 - 12"x47 1/2"	Kaleido 20x15 - 8"x6"
		± 9,5	± 9,5	± 9,5	± 9,5	± 9,5	± 9,5	± 9,5	± 9,5
 Opal	Nat/Ret	03079	02936	02981				02944	
	Lap/Ret								
 Nacre	Nat/Ret	03081	02937		02980			02944	
	Lap/Ret								
 Shimmer	Nat/Ret	03082	02938					02944	02989
	Lap/Ret								
 Reflex	Nat/Ret	03083	02939					02944	
	Lap/Ret								
 Rust	Nat/Ret	03084	02941			02945		02944	02990
	Lap/Ret								
 Deep	Nat/Ret	03085	02942				02946	02943	
	Lap/Ret								

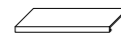
Riepilogo Gamma

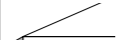
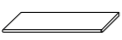
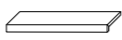
Collection
Serie
Gamme

		Pezzi Speciali Special Pieces							
									
		Gradino Costa Retta 30*119,5 - 12*47½"	Battiscopa 4,5*60 - 1¼*24"	Bacchetta Jolly 1,5*119,5 - ¾*47½"	Unghia Jolly 1,5*1,5 - ¾*¾"	Gradone 30*90 - 12*36"	Elemento L 30*90 - 12*36"	Griglia Scolo 18*90 - 7¼*36"	
		± 9,5	± 9,5	± 9,5	± 9,5	± 20	± 20	± 20	
Formati Sizes	Opal	Nat/Ret	03097	02893	03111	03124			
		Lap/Ret	03104	02899	03117	03131			
Formati Sizes	Nacre	Nat/Ret	03098	02894	03112	03125			
		Lap/Ret	03105	02901	03118	03132			
Formati Sizes	Shimmer	Nat/Ret	03099	02895	03113	03126			
		Lap/Ret	03106	02902	03119	03133			
Formati Sizes	Reflex	Grip/Ret					03137	03141	03149
		Nat/Ret	03101	02896	03114	03127			
Formati Sizes	Rust	Lap/Ret	03107	02903	03121	03134			
		Grip/Ret					03138	03142	03151
Formati Sizes	Deep	Nat/Ret	03102	02897	03115	03128			
		Lap/Ret	03108	02904	03122	03135			
Formati Sizes		Nat/Ret	03103	02898	03116	03129			
		Lap/Ret	03109	02905	03123	03136			
Formati Sizes		Grip/Ret					03139	03143	03152

Pezzi Speciali su Richiesta - Special pieces upon request
Formstücke auf Anfrage - Pièces spéciales sur demande



Gradone Angolare Sx/Dx 20 mm
Grip/Ret 30*90 - 12*36" ± 20



Griglia Scolo Angolare Sx/Dx 20 mm
Grip/Ret 18*90 - 7¼*36" ± 20

Imballi

Packing
Verpackung
Emballage

Formati Sizes	± MM	Pezzi Scatola Pieces/Box Stck/Karton Carreaux/Boîte	Mq/Scatola Sqmt/Box Qm/Karton M2/Boîte	Kg/Scatola Kgs/Box Kg/Karton Kg/Boîte	Scatole/Paletta Boxes/Pallet Karton/Palette Boîte/Palette	Mq/Paletta Sqmt/Pallet Qm/Pallet M2/Palette	Kg/Paletta Kgs/Pallet Kg/Pallet Kg/Palette	Formato Paletta Size Pallet Format Palette Dim. Palette
119,5*119,5 (47½*47½") Nat/Ret - Lap/Ret	P	9	2,86	55,50	22	62,92	1221	132x132x53
90*90 (36*36") Grip/Ret	P	20	0,81	36,50	30	24,3	1095	94x94x105
89,5*89,5 (35½*35½") Nat/Ret - Lap/Ret	P	9,5	1,602	36,50	20	32,04	730	94x110x60
60*119,5 (24*47½") Nat/Ret	P	9,5	1,434	31,00	30	43,02	930	120x80x75
60*119,5 (24*47½") Lap/Ret	P	9,5	1,434	32,00	30	43,02	960	120x80x75
60*60 (24*24") Nat/Ret	P	9,5	1,08	21,50	40	43,2	860	120x80x75
60*60 (24*24") Lap/Ret	P	9,5	1,08	22,50	40	43,2	900	120x80x75
30*60 (12*24") Nat/Ret	P	9,5	1,08	21,50	48	51,84	1032	120x80x75
30*60 (12*24") Lap/Ret	P	9,5	1,08	22,50	48	51,84	1080	120x80x75
30*119,5 (12*47½") Raku Nat/Ret	P	9,5	0,717	15,50	30	21,51	465	120x80x45
60*60 (24*24") Jade - Zaphire - Gold - Platinum Nat/Ret	P	9,5	0,72	14,50	32	23,04	464	120x80x75
30*60 (12*24") Garage Nat/Ret	P	9,5	1,08	21,50	40	43,2	860	120x80x75
30*60 (12*24") Tensegrity Nat/Ret	P	9,5	1,08	21,50	40	43,2	860	120x80x75
20*15 (8*6") Kaleido Nat/Ret	P	9,5	0,750	15,50	36	-	-	-
Pezzi Speciali / Special Pieces								
30*119,5 (12*47½") Gradino Costa Retta Nat/Ret - Lap/Ret	P	9,5	0,717	17,00	20	-	-	-
4,5*60 (1¼*24") Battiscopa Nat/Ret - Lap/Ret	P	9,5	0,378 m.l. 8,40	8,00	80	-	-	-
1,5*119,5 (¾*47½") Bacchetta Jolly Nat/Ret - Lap/Ret	P	9,5	0,108	2,50	48	-	-	-
1,5*1,5 (¾*¾") Unghia Jolly Nat/Ret - Lap/Ret	P	9,5	0,001	0,50	48	-	-	-
30*90 (12*36") Gradone Grip/Ret	P	20	0,54	24,50	36	-	-	-
30*90 (12*36") Elemento L Grip/Ret	P	20	0,54	28,50	27	-	-	-
18*90 (7¼*36") Griglia Scolo Grip/Ret	P	20	0,162	7,50	48	-	-	-

Pezzi Speciali

Special pieces
Formstücke
Pièces spéciales

Battiscopa Nat/Ret 4,5×60 – 1¼"×24" ± 9,5
Battiscopa Lap/Ret 4,5×60 – 1¼"×24" ± 9,5

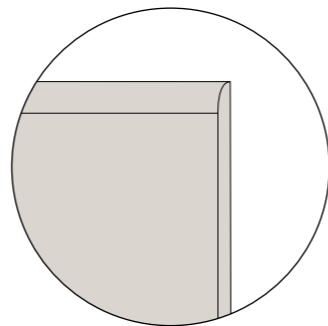
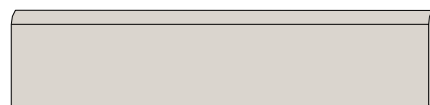

Gradino Costa Retta Nat/Ret 30×119,5 – 12"×47½" ± 9,5
Gradino Costa Retta Lap/Ret 30×119,5 – 12"×47½" ± 9,5
(costa retta ottenuto per taglio e incollaggio - obtained by cutting and gluing)

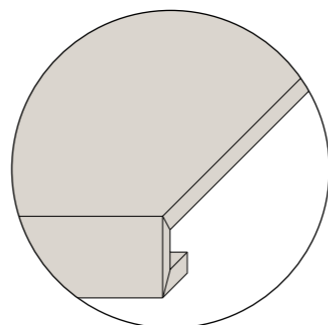
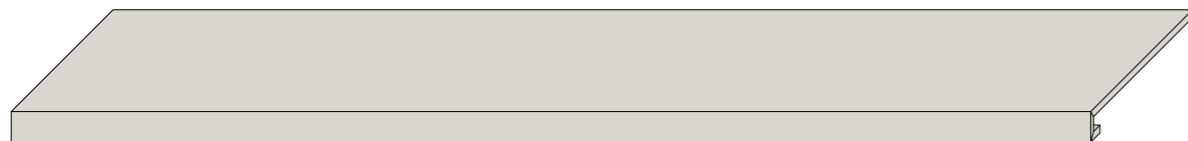

Elemento L 20 mm Grip/Ret 30×90 – 12"×36" ± 20
(ottenuto per taglio e incollaggio - obtained by cutting and gluing)

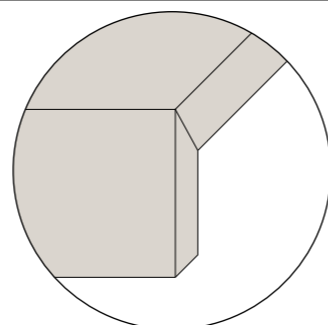

Gradone 20 mm Grip/Ret 30×90 – 12"×36" ± 20
(toro tecnico - full bullnose edge)

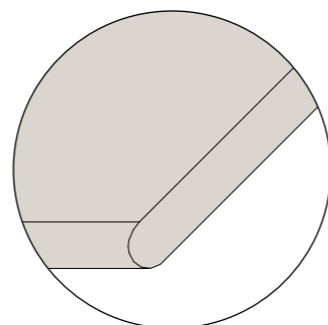

Griglia Scolo 20 mm Grip/Ret 18×90 – 7½"×36" ± 20
(ottenuto per taglio e incollaggio - obtained by cutting and gluing)

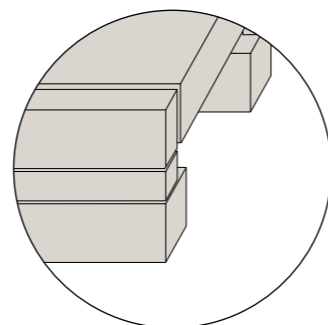
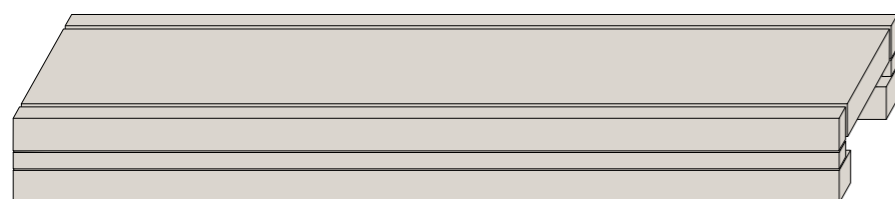

Pezzi Speciali

Special pieces
Formstücke
Pièces spéciales

Bacchetta Jolly Nat/Ret 1,5×119,5 – ⅝"×47½" ± 9,5
Bacchetta Jolly Lap/Ret 1,5×119,5 – ⅝"×47½" ± 9,5

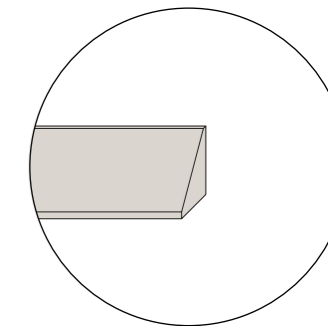
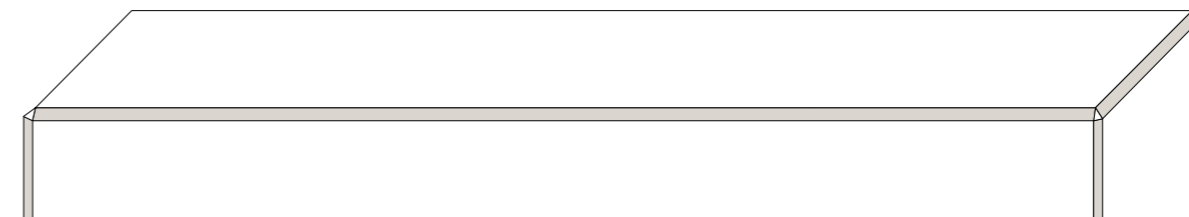

Unghia Jolly Nat/Ret 1,5×1,5 – ⅝"×⅝" ± 9,5
Unghia Jolly Lap/Ret 1,5×1,5 – ⅝"×⅝" ± 9,5

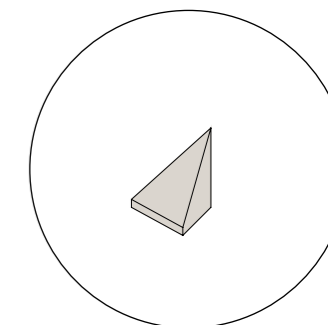
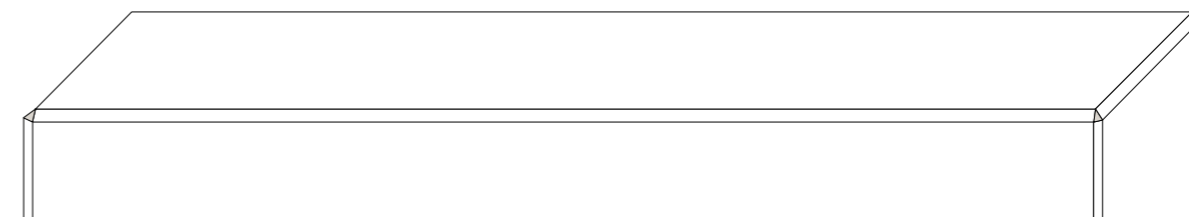

Elementi di Raccordo Bacchetta e Unghia Jolly

Universal Bevel Filler Strip and Corner Filler Chip
Verbindungselemente Universalleiste und -aussenecke
Éléments de raccord baguette et onglet Jolly



Angoli Muretti / Wall Bevel Corners /
Ecke für Zwischenwände / Angles murets



Spigoli Scale / Staircase Bevel Edge /
Kanten für Treppen / Arêtes escaliers

Pezzi Speciali su Richiesta

Special pieces upon request
Formstücke auf Anfrage
Pièces spéciales sur demande

Gradone Angolare Sx/Dx 20 mm Grip/Ret 30x90 - 12"x36" ± 20
(toro tecnico - full bullnose edge)



Angolo Sx

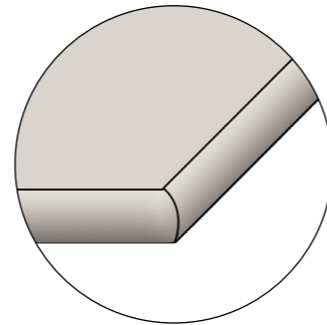

Angolo Dx

Griglia Scolo Angolare Sx/Dx 20 mm Grip/Ret 18x90 - 7 1/4"x36" ± 20
(ottenuto per taglio e incollaggio - obtained by cutting and gluing)

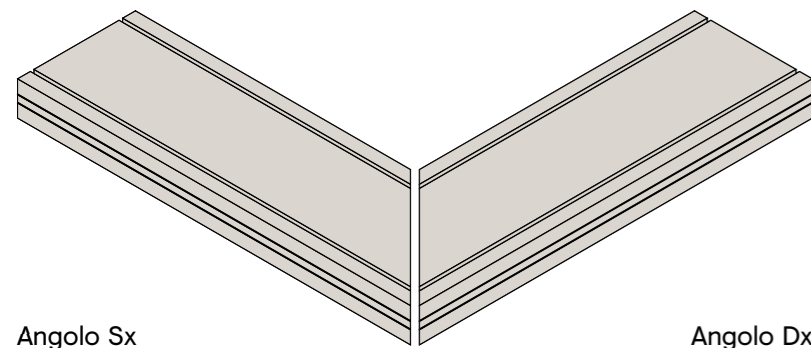

Angolo Sx

Angolo Dx

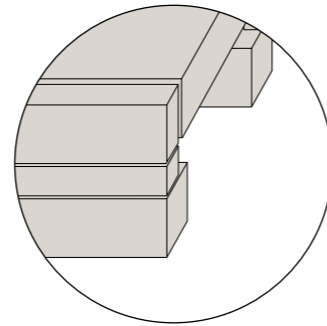

Caratteristiche Tecniche

Technical characteristics
Technische daten
Caracteristiques techniques

CLASSIFICAZIONE SECONDO NORME CEN/ISO GRUPPO B1A EN 14411 - ISO 13006 - CLASSIFICATION IN ACCORDANCE WITH CEN/ISO STANDARDS B1A EN 14411 - ISO 13006
KLASSIFIZIERUNG GEMÄSS CEN/ISO-NORMEN GRUPPE B1A EN 14411 - ISO 13006 - CLASSIFICATION SELON LES NORMES CEN/ISO GROUPE B1A EN 14411 - ISO 13006

CARATTERISTICA TECNICA TECHNICAL CHARACTERISTIC TECHNISCHE DATE CARACTÉRISTIQUE TECHNIQUE	NORMA NORM NORM NORME	VALORE PRESCRITTO VALUE REQUIRED NORMVORGABE VALEUR PRESCRIPTE	VALORE MEDIO MEAN VALUE MITTELWERT VALEUR MOYENNE CERAMICHE PIEMME FLOOR AND MORE	USA TESTS ASTM C-499 ASTM C-485 ASTM C-502	VALORE MEDIO MEAN VALUE MITTELWERT VALEUR MOYENNE CERAMICHE PIEMME FLOOR AND MORE
LUNGHEZZA E LARGHEZZA LENGHT AND WIDTH / LÄNGE UND BREITE / LONGUEUR ET LARGEUR		±0.6% (±2.00 MM)			
SPESSORE THICKNESS / STÄRKE / ÉPAISSEUR		±5% (±0.5 MM)			
RETILINEITÀ LATI WARPAGES OF EDGES / GERADHEIT DER KANTEN / RÉCITITUDE DES ARÊTES	ISO 10545.2	±0.5% (±1.5 MM)	CONFORME IN ACCORDANCE ERFÜLLT CONFORME		IN ACCORDANCE
ORTOGONALITÀ WEDGING / RECHTWINKLIGKEIT / ORTHOGONALITÉ		±0.5% (±2.00 MM)			
PLANARITÀ FLATNESS / PLANITÄT / PLANIMÉTRIE		±0.5% (±2.00 MM)			
ASSORBIMENTO % D'ACQUA WATER ABSORPTION WASSERANNAHME % ABSORPTION D'EAU %	ISO 10545.3	≤ 0.5%	CONFORME IN ACCORDANCE ERFÜLLT CONFORME	ASTM C-373	IN ACCORDANCE
RESISTENZA ALLA FLESSIONE BENDING STRENGTH BIEGEZUGFESTIGKEIT RÉSISTANCE À LA FLEXION	ISO 10545.4	≥ 35N/MM²	CONFORME IN ACCORDANCE ERFÜLLT CONFORME	ASTM C-648 250 LBS OR GREATER	IN ACCORDANCE
DILATAZIONE TERMICA LINEARE TRA 20° E 100° C LINEAR THERMAL EXPANSION BETWEEN 20° AND 100° C LINEARE WÄRMEAUSSDEHNUNG ZWISCHEN 20° UND 100° C DILATATION THERMIQUE LINEAIRE ENTRE 20° ET 100° C	ISO 10545.8	SECONDO I DATI DEL COSTRUTTORE ACCORDING TO BUILDERS SPECIFICATIONS LAUT ANGABEN DES HERSTELLERS SELON LES ELEMENTS DU COSTRUCTEUR	≈ 7X10 ⁻⁶ C ⁻¹		
RESISTENZA AGLI SBALZI TERMICI THERMAL SHOCK RESISTANCE TEMPERATURWECHSELBESTÄNDIGKEIT RÉSISTANCE AUX ÉCARTS DE TEMPÉRATURE	ISO 10545.9	RICHIESTA REQUEST BITTE DEMANDE	RESISTENTE RESISTANT WIDERSTEHEND RÉSISTANT		
RESISTENZA AL GELO FROST RESISTANCE FROSTBESTÄNDIGKEIT RÉSISTANCE AU GEL	ISO 10545.12	RICHIESTA REQUEST BITTE DEMANDE	RESISTENTE RESISTANT WIDERSTEHEND RÉSISTANT	ASTM C-1026	IN ACCORDANCE
RESISTENZA ALL'ATTACCO CHIMICO RESISTANCE TO CHEMICAL ATTACK BESTÄNDIGKEIT GEGEN CHEMIKALIEN RÉSISTANCE À L'ATTAQUE CHIMIQUE	ISO 10545.13	SECONDO I DATI DEL COSTRUTTORE ACCORDING TO BUILDERS SPECIFICATIONS LAUT ANGABEN DES HERSTELLERS SELON LES ELEMENTS DU COSTRUCTEUR	RESISTENTE RESISTANT WIDERSTEHEND RÉSISTANT	ASTM C-650	IN ACCORDANCE
RESISTENZA DEI COLORI ALLA LUCE COLOURS RESISTANCE TO LIGHT LICHTBESTÄNDIGKEIT RÉSISTANCE DES COULEURS À LA LUMIÈRE	DIN 51094	NESSUNA ALTERAZIONE NO ALTERATION KEINE VERÄNDERUNG AUCUNE ALTERATION	CONFORME IN ACCORDANCE ERFÜLLT CONFORME		
RESISTENZA ALLE MACCHIE STAIN RESISTANCE FLECKENFESTIGKEIT RÉSISTANCE AUX TACHES	ISO 10545.14	≥ CLASSE 3 METODO DI PROVA DISPONIBILE TEST METHOD AVAILABLE VERFÜGBARE PRÜFMETHODE METHODE D'ESSAI DISPONIBILE	CONFORME IN ACCORDANCE ERFÜLLT CONFORME		
RESISTENZA ALLO SCIVOLAMENTO SLIP/PADE RESISTANCE RUTSCHSICHERHEIT RÉSISTANCE AU GLISSEMENT	DIN 51130 *	9 ≤ R ≤ 13	NAT LAP GRIP 20MM	R10 ASTM C-1028 * COF ≥ 0.6 DRY ≥ 0.6 WET	NAT LAP GRIP 20MM
	DIN 51097 *	A,B,C	NAT LAP GRIP 20MM	A*B ANSI * 137.1-2012 DCOF > 0.42 WET	NAT LAP GRIP 20MM
	BS EN 7976-2*	> 36 DRY > 36 WET	NAT LAP GRIP 20MM		NAT LAP GRIP 20MM

*TRATTANDOSI DI NORMATIVE NAZIONALI, I METODI DI PROVA, I REQUISITI E LE CLASSIFICAZIONI VARIANO DA PAESE A PAESE. IL VALORE ATTESO DALLA RESISTENZA ALLO SCIVOLAMENTO DELLA PRODUZIONE DI INDUSTRIE CERAMICHE PIEMME S.P.A., PUÒ VARIARE IN BASE AL LOTTO PRODUTTIVO. SPECIFICA DOCUMENTAZIONE È DISPONIBILE SU RICHIESTA.
TEST METHODS, REQUIREMENTS AND CLASSIFICATIONS DIFFER FROM COUNTRY TO COUNTRY, ACCORDING TO THE NATIONAL REGULATIONS. THE EXPECTED VALUE OF SLIPPAGE RESISTANCE OF PRODUCTS BY INDUSTRIE CERAMICHE PIEMME S.P.A. MAY VARY DEPENDING ON THE PRODUCTION BATCH. SPECIFIC DOCUMENTS ARE AVAILABLE UPON REQUEST.
PRÜFVERFAHREN, ERFORDERNISSE UND KLASSIFIKATIONEN SIND VERSCHIEDEN VON LAND ZU LAND, GEMÄSS DER NATIONALEN VORSCHRIFTEN. DER ERWARTUNGSWERT DER RUTSCHSICHERHEIT DER PRODUKTE VON INDUSTRIE CERAMICHE PIEMME S.P.A. KANN SICH - JE NACH DER PRODUKTIONSPARTIE - VERÄNDERN. SPEZIFISCHE UNTERLAGEN SIND AUF VERLANGEN ZUR VERFÜGUNG.
LES MÉTHODES D'ESSAI, LES RÉQUISITIONS ET LES CLASSIFICATIONS CHANGENT DE PAYS À PAYS, SELON LES RÉGLEMENTATIONS NATIONALES. LA VALEUR ATTENDUE DE RÉSISTANCE AU GLISSEMENT DES PRODUITS DE INDUSTRIE CERAMICHE PIEMME S.P.A. PEUT VARIER EN FONCTION DU LOT DE PRODUCTION. UNE DOCUMENTATION SPÉCIFIQUE EST DISPONIBLE SUR DEMANDE.

ELENCO DELLE SERIE CERTIFICATE E CLASSIFICAZIONI DISPONIBILI A RICHIESTA - LIST OF CERTIFIED SERIES AND CLASSIFICATIONS AVAILABLE UPON REQUEST
LISTE DER GEPRÜFTEN SERIE UND KLASSIFIZIERUNGEN AUF ANFRAGE ERHÄLTlich - LISTE DES SERIES CERTIFIÉES ET DES CLASSEMENTS DISPONIBLES SUR DEMANDE



CERAMICHE PIEMME
FLOOR AND MORE



Norme per la posa e la manutenzione

Installation and maintenance instructions

Verlegung, reiningung und pflege

Guide a la pose et l'entretien

Verlegung, reiningung und pflege

Guide a la pose et l'entretien

Verlegung, reiningung und pflege

Guide a la pose et l'entretien

Verlegung, reiningung und pflege

Guide a la pose et l'entretien

Verlegung, reiningung und pflege

Guide a la pose et l'entretien

Verlegung, reiningung und pflege

Guide a la pose et l'entretien

Verlegung, reiningung und pflege

Guide a la pose et l'entretien

Verlegung, reiningung und pflege

Guide a la pose et l'entretien

Verlegung, reiningung und pflege

Guide a la pose et l'entretien

Verlegung, reiningung und pflege

Guide a la pose et l'entretien

Verlegung, reiningung und pflege

Guide a la pose et l'entretien

Verlegung, reiningung und pflege

Guide a la pose et l'entretien

Verlegung, reiningung und pflege

Guide a la pose et l'entretien

Verlegung, reiningung und pflege

Guide a la pose et l'entretien

Verlegung, reiningung und pflege

Guide a la pose et l'entretien

Verlegung, reiningung und pflege

Guide a la pose et l'entretien

Verlegung, reiningung und pflege

Guide a la pose et l'entretien

Verlegung, reiningung und pflege

Guide a la pose et l'entretien

Verlegung, reiningung und pflege

Guide a la pose et l'entretien

Verlegung, reiningung und pflege

Guide a la pose et l'entretien

Verlegung, reiningung und pflege

Guide a la pose et l'entretien

Verlegung, reiningung und pflege

Guide a la pose et l'entretien

Verlegung, reiningung und pflege

Guide a la pose et l'entretien

Verlegung, reiningung und pflege

Guide a la pose et l'entretien

Verlegung, reiningung und pflege

Guide a la pose et l'entretien

Verlegung, reiningung und pflege

Guide a la pose et l'entretien

Verlegung, reiningung und pflege

Guide a la pose et l'entretien

Verlegung, reiningung und pflege

Guide a la pose et l'entretien

Verlegung, reiningung und pflege

Guide a la pose et l'entretien

Verlegung, reiningung und pflege

Guide a la pose et l'entretien

Verlegung, reiningung und pflege

Guide a la pose et l'entretien

Verlegung, reiningung und pflege

Guide a la pose et l'entretien

Verlegung, reiningung und pflege

Guide a la pose et l'entretien

Verlegung, reiningung und pflege

Guide a la pose et l'entretien

Verlegung, reiningung und pflege

Guide a la pose et l'entretien

Verlegung, reiningung und pflege

Guide a la pose et l'entretien

Verlegung, reiningung und pflege

Guide a la pose et l'entretien

Verlegung, reiningung und pflege

Guide a la pose et l'entretien

Verlegung, reiningung und pflege

Guide a la pose et l'entretien

Verlegung, reiningung und pflege

Guide a la pose et l'entretien

Verlegung, reiningung und pflege

Guide a la pose et l'entretien

Verlegung, reiningung und pflege

Guide a la pose et l'entretien

Verlegung, reiningung und pflege

Guide a la pose et l'entretien

Verlegung, reiningung und pflege

Guide a la pose et l'entretien

Verlegung, reiningung und pflege

Guide a la pose et l'entretien

Verlegung, reiningung und pflege

Guide a la pose et l'entretien

Verlegung, reiningung und pflege

Guide a la pose et l'entretien

TIPO DI SPORCO	INDICAZIONI PER LA PULIZIA
Birra, Caffè, Gelato, Vino Gomma Pneumatico, Grassi vegetali e animali, Inchiostri, Lampostil Olii Meccanici, Residui di scotch Olio di lino, PennarelloResine Smalti, Tintura per capelli	Prodotti a Base Alcalina
Cera protettiva anti-abrasione, Depositi calcarei, Macchie di ruggine	Prodotti a Base Acida
Cera di candela, Residui di scotch	Solventi
Per ulteriori informazioni specifiche consultare l'area tecnica sul sito Piemme: www.ceramichepiemme.it	

TYPE OF STAIN	CLEANING SUGGESTIONS
beer, coffee, wine, ice cream vegetable and animal fats, rubber, remains of scotch tape, grease from machines, linseed oil, felt tip pens, paints, inks, hair dye	Alkaline-based detergent
protective anti-abrasion wax, calcareous residuals, rust stains	Acid-based detergent
candle wax, remains of scotch-tape	Solvents
For further specific details please visit the technical area on Piemme website: www.ceramichepiemme.it	

VERSCHMUTZUNGSART	REINIGUNGSHINWEISE
Bier, Wein, Eis, Kaffee Tierische oder pflanzliche Fette Gummi, Kleberbandresten Schmieröl, Tinte, Leöl, Filzstift, Harz oder Lack, Haarfarbe	Alakalische Reinigungsmittel
Kratzenschutz-Wachs, Kalkablagerunge, Rostflecken	Säure-Reinigungsmittel
Kerzenwachs Kleberbandresten	Lösungsmittel
Weitere Einzelheiten finden Sie in dem technischen Bereich des Piemme website: www.ceramichepiemme.it	

TYPE DE TACHE	NETTOYAGE CONSEIL
Bière, Vin, Glace, Café, Graisses végétales et animales, Encres, Résidus de scotch, Huile de graissage, Hile de lin Crayon feutre Émaux, Teinture pour cheveux, Caoutchouc pour pneus	Détergents à base alcaline
Cire de protection anti abrasion, Dépôts de calcaire, Tache de rouille	Détergents à base d'acide
Cire de bougie Résidus de scotch	Solvant
Pour d'ultérieures Information spécifiques consulter le département technique du site Piemme: www.ceramichepiemme.it	

Guida alla Lettura

Reading Guide

Leseanleitung

Guide à la lecture

Reading Guide

Leseanleitung

Reading Guide

Reading Guide

Reading Guide

Reading Guide

Reading Guide

Reading Guide

Reading Guide

Reading Guide

Reading Guide

Reading Guide

Reading Guide

Reading Guide

Reading Guide

Reading Guide

Reading Guide

Reading Guide

Reading Guide

Reading Guide

Reading Guide

Reading Guide

Reading Guide

Reading Guide

Reading Guide

Reading Guide

Reading Guide

Reading Guide

Reading Guide

Reading Guide

Reading Guide

Reading Guide

Reading Guide

Reading Guide

Reading Guide

Reading Guide

Reading Guide

Reading Guide

Reading Guide

Reading Guide

Reading Guide

Reading Guide

Reading Guide

Reading Guide

Reading Guide

Reading Guide

Reading Guide

Reading Guide

Reading Guide

Reading Guide

Reading Guide

Reading Guide

Reading Guide

Reading Guide

Reading Guide

Reading Guide

Reading Guide

Reading Guide

Reading Guide

Reading Guide

Reading Guide

Reading Guide

Reading Guide

Reading Guide

Reading Guide

Reading Guide

Reading Guide

Reading Guide

Reading Guide

Reading Guide

Reading Guide

Reading Guide

Reading Guide

Reading Guide

Reading Guide

Reading Guide

Reading Guide

Reading Guide

Reading Guide

Reading Guide

Reading Guide

Reading Guide

Reading Guide

Reading Guide

Reading Guide

Reading Guide

Reading Guide

Reading Guide

Reading Guide

Reading Guide

Reading Guide

Reading Guide

Reading Guide

Reading Guide

Reading Guide

Reading Guide

Reading Guide

Reading Guide

Reading Guide

Reading Guide

Reading Guide

Reading Guide

Reading Guide

Reading Guide

Reading Guide

Reading Guide

Reading Guide

Reading Guide

Reading Guide

Reading Guide

Reading Guide

Reading Guide

Reading Guide

Reading Guide

Reading Guide

Reading Guide

Reading Guide

Reading Guide

Reading Guide

Reading Guide

Reading Guide

Reading Guide

Reading Guide

Reading Guide

Reading Guide

Reading Guide

Reading Guide

Reading Guide

Reading Guide

Reading Guide

Reading Guide

Reading Guide

Reading Guide

Reading Guide

Reading Guide

Reading Guide

Reading Guide

Reading Guide

Reading Guide

Reading Guide

Reading Guide

Reading Guide

Reading Guide

Reading Guide



Ceramics of Italy rappresenta la volontà dell'industria italiana delle piastrelle di ceramica nel diffondere e promuovere una nuova valenza della piastrella di ceramica: non più solo un prodotto per l'industria delle costruzioni, ma punto di riferimento per stile e creatività per lo sviluppo di una nuova cultura dell'abitare Made in Italy.

Ceramics of Italy represents the willingness of the Italian ceramic tile industry to spread and promote a new concept of ceramic tile: no longer just a product for the construction industry, but a focal point for style and creativity in the development of a new culture of living Made in Italy.

Una storia tutta italiana

Piemme dal 1962, anno della sua fondazione, è protagonista indiscussa del vero Made in Italy, quello fatto di eccellenza, passione e creatività. Oggi tutti i materiali Piemme sono prodotti con tecnologia d'avanguardia come la decorazione digitale inkjet HD, la cottura in forni ad energia pulita a recupero di calore, la rettifica e levigatura in linea "one roof" e la verifica elettronica dello standard qualitativo.

An all-Italian story

Since 1962, the year of its foundation, Piemme has been the undisputed protagonist of real Made in Italy, that which consists of excellence, passion and creativity. Today, all Piemme materials are made using cuttingedge technology such as HD inkjet digital decoration, firing in heat-recycling cleanenergy kilns, "one roof" grinding and polishing line and electronic quality standard control.

Eine ganz italienische Geschichte

Seit dem Gründungsjahr 1962 ist Piemme ein unangefochtener Hauptakteur des echten Made in Italy: jenem, das auf Exzellenz, Leidenschaft und Kreativität gründet. Alle Piemme Erzeugnisse werden heute unter Einsatz von Spitzentechnologie produziert, wie zum Beispiel mit der digitalen Inkjet-Dekoration, dem Brennen in Öfen mit grüner Energie und Wärmerückgewinnung, dem Schleifen und Polieren in der Linie „unter einem Dach“ sowie der elektronischen Prüfung des Qualitätsniveaus.

Une histoire toute italienne

Depuis 1962, l'année de sa fondation, Piemme est la protagoniste indiscutée du Made in Italy, basé sur l'excellence, la passion et la créativité. Aujourd'hui toutes les phases du cycle de fabrication Piemme sont issues d'une technologie à l'avant-garde comme la décoration numérique inkjet HD, la cuisson dans des fours à énergie propre et à récupération de chaleur, la rectification et le polissage en en ligne "one roof" et la vérification électronique de la qualité.

CERAMICHE PIEMME

FLOOR AND MORE

INDUSTRIE CERAMICHE PIEMME S.P.A.
VIA DEL CROCIALE 42/44, 41042 FIORANO (MO) - ITALY
T. +39 0536.849111 - F. +39 0536.849402
WWW.CERAMICHEPIEMME.IT - INFO@CERAMICHEPIEMME.IT